

Description:

GPS/GLONASS/BEIDOU/COMPASS/Galileo

PART NUMBER: GPSGBXXXX

Series: Internal Active GPS

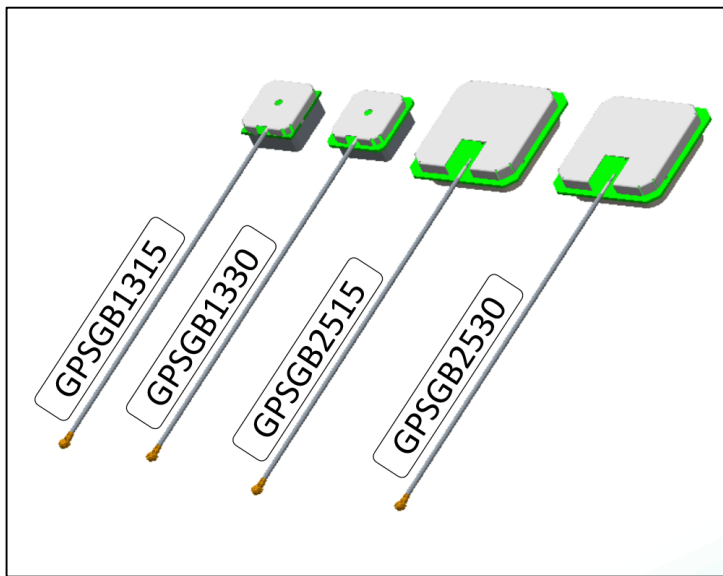
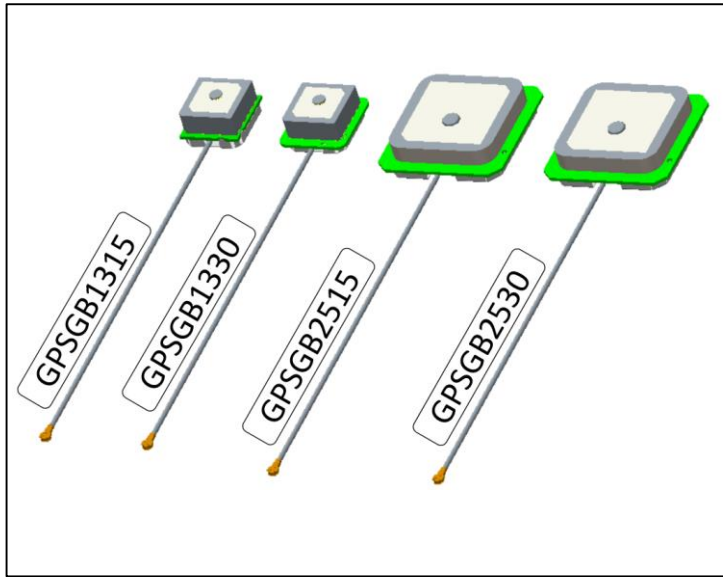

Features:

- Satellite navigation active antenna
- Ultra low noise amplifiers
- High Gain (30dB) and Low Gain (15dB) LNA variants available
- High rejection filters to suppress out of band interference

Applications:

- GPS, GLONASS, BeiDou, Compass, Galileo satellite navigation system
- Asset tracking, Fleet management, IoT, M2M

All dimensions are in mm / inches

Issue: 1626

In the effort to improve our products, we reserve the right to make changes judged to be necessary.

CONFIDENTIAL AND PROPRIETARY INFORMATION

This document contains confidential and proprietary information of Pulse Electronics, Inc. (Pulse) and is protected by copyright, trade secret and other state and federal laws. Its receipt or possession does not convey any rights to reproduce, disclose its contents, or to manufacture, use or sell anything it may describe. Reproduction, disclosure or use without specific written authorization of Pulse is strictly forbidden.

For more information:

Pulse Worldwide Headquarters
12220 World Trade Drive
San Diego, CA 92128
USA
Tel: 1-858-674-8100

Pulse/Larsen Antennas
3611 NE 112th Ave
Vancouver, WA 98682
USA
Tel: 1-360-944-7551

Europe Headquarters
Pulse GmbH & Do, KG
Zeppelinstrasse 15
Herrenberg, Germany
Tel: 49 7032 7806 0

Pulse (Suzhou) Wireless Products Co, Inc.
99 Huo Ju Road(#29 Bldg,4th Phase
Suzhou New District
Jiangsu Province, Suzhou 215009 PR China
Tel: 86 512 6807 9998



Description:

GPS/GLONASS/BEIDOU/COMPASS/Galileo

PART NUMBER: GPSGBXXXX

Series: Internal Active GPS

This document covers all product variants of the following product family:

Projects	Ceramic Size(mm)	PCB Size (mm)	Thickness (mm)	Cable	Connector
GPSGB1315	13 X 13 X 5	14 X 15 X 0.8	8.15	Φ: 1.13mm L : 100mm	I-PEX MHF 20278-112R-13 compatible with U.FL connector
GPSGB1330		16 X 17 X 0.8	8.15		
GPSGB2515	25 X 25 X 4	30 X 30 X 0.8	8		
GPSGB2530					

Issue: 1626

In the effort to improve our products, we reserve the right to make changes judged to be necessary.

CONFIDENTIAL AND PROPRIETARY INFORMATION

This document contains confidential and proprietary information of Pulse Electronics, Inc. (Pulse) and is protected by copyright, trade secret and other state and federal laws. Its receipt or possession does not convey any rights to reproduce, disclose its contents, or to manufacture, use or sell anything it may describe. Reproduction, disclosure or use without specific written authorization of Pulse is strictly forbidden.

Description:

GPS/GLONASS/BEIDOU/COMPASS/Galileo

PART NUMBER: GPSGBXXXX

Series: Internal Active GPS

ELECTRICAL SPECIFICATIONS

GPSGB1315

Frequency	1561.098 ± 2.046/ 1575.42 ± 1.023/ 1602.5625 ± 4	MHz
Nominal Impedance	50	Ω
VSWR	2:1	
Gain (Radiating element)	-1	dBic ± 1 dB
Gain (LNA gain)	15	dB ± 2 dB
Polarization	RHCP	
Out of Band Rejection		
698 MHz	>60	dB
960MHz	>50	dB
1710MHz	>55	dB
2170MHz	>55	dB
2400MHz	>55	dB
2700MHz	>55	dB

Series: Internal Active GPS

Description:

GPS/GLONASS/BEIDOU/COMPASS/Galileo

PART NUMBER: GPSGBXXXX

ELECTRICAL SPECIFICATIONS

GPSGP1330

Frequency	1561.098 ± 2.046/ 1575.42 ± 1.023/ 1602.5625 ± 4	MHz
Nominal Impedance	50	Ω
VSWR	2:1	
Gain (Radiating element)	-1	dBic ± 1 dB
Gain (LNA gain)	30	dB ± 2 dB
Polarization	RHCP	
Out of Band Rejection		
698 MHz	>70	dB
960MHz	>65	dB
1710MHz	>60	dB
2170MHz	>65	dB
2400MHz	>65	dB
2700MHz	>65	dB

Issue: 1626

In the effort to improve our products, we reserve the right to make changes judged to be necessary.

CONFIDENTIAL AND PROPRIETARY INFORMATION

This document contains confidential and proprietary information of Pulse Electronics, Inc. (Pulse) and is protected by copyright, trade secret and other state and federal laws. Its receipt or possession does not convey any rights to reproduce, disclose its contents, or to manufacture, use or sell anything it may describe. Reproduction, disclosure or use without specific written authorization of Pulse is strictly forbidden.

Description:

GPS/GLONASS/BEIDOU/COMPASS/Galileo

PART NUMBER: GPSGBXXXX

Series: Internal Active GPS

ELECTRICAL SPECIFICATIONS

GPSGP2515

Frequency	1561.098 ± 2.046/ 1575.42 ± 1.023/ 1602.5625 ± 4	MHz
Nominal Impedance	50	Ω
VSWR	2:1	
Gain (Radiating element)	1	dBic ± 1 dB
Gain (LNA gain)	15	dB ± 2 dB
Polarization	RHCP	
Out of Band Rejection		
698 MHz	>60	dB
960MHz	>50	dB
1710MHz	>55	dB
2170MHz	>55	dB
2400MHz	>55	dB
2700MHz	>55	dB

Description:

GPS/GLONASS/BEIDOU/COMPASS/Galileo

PART NUMBER: GPSGBXXXX

Series: Internal Active GPS

ELECTRICAL SPECIFICATIONS

GPSGB2530

Frequency	1561.098 ± 2.046/ 1575.42 ± 1.023/ 1602.5625 ± 4	MHz
Nominal Impedance	50	Ω
VSWR	2:1	
Gain (Radiating element)	1	dBic ± 1 dB
Gain (LNA gain)	30	dB ± 2 dB
Polarization	RHCP	
Out of Band Rejection		
698 MHz	>70	dB
960MHz	>65	dB
1710MHz	>60	dB
2170MHz	>65	dB
2400MHz	>65	dB
2700MHz	>65	dB

Series: Internal Active GPS

Description:

GPS/GLONASS/BEIDOU/COMPASS/Galileo

PART NUMBER: GPSGBXXXX

ELECTRICAL SPECIFICATIONS

ALL GPSGBXXXX

Noise Figure	<2.4 dB
Operating Voltage	3.3-5 Vdc±0.5V
Current Consumption	<6 mA

Series: Internal Active GPS

Description:

GPS/GLONASS/BEIDOU/COMPASS/Galileo

PART NUMBER: GPSGBXXXX

MECHANICAL SPECIFICATIONS

Fixing system

Adhesive Tape

ENVIRONMENTAL SPECIFICATIONS

Operating temperature

-40 ~ +85° C

Series: Internal Active GPS

Description:

GPS/GLONASS/BEIDOU/COMPASS/Galileo

PART NUMBER: GPSGBXXXX

MECHANICAL DRAWING

GPSGB1315

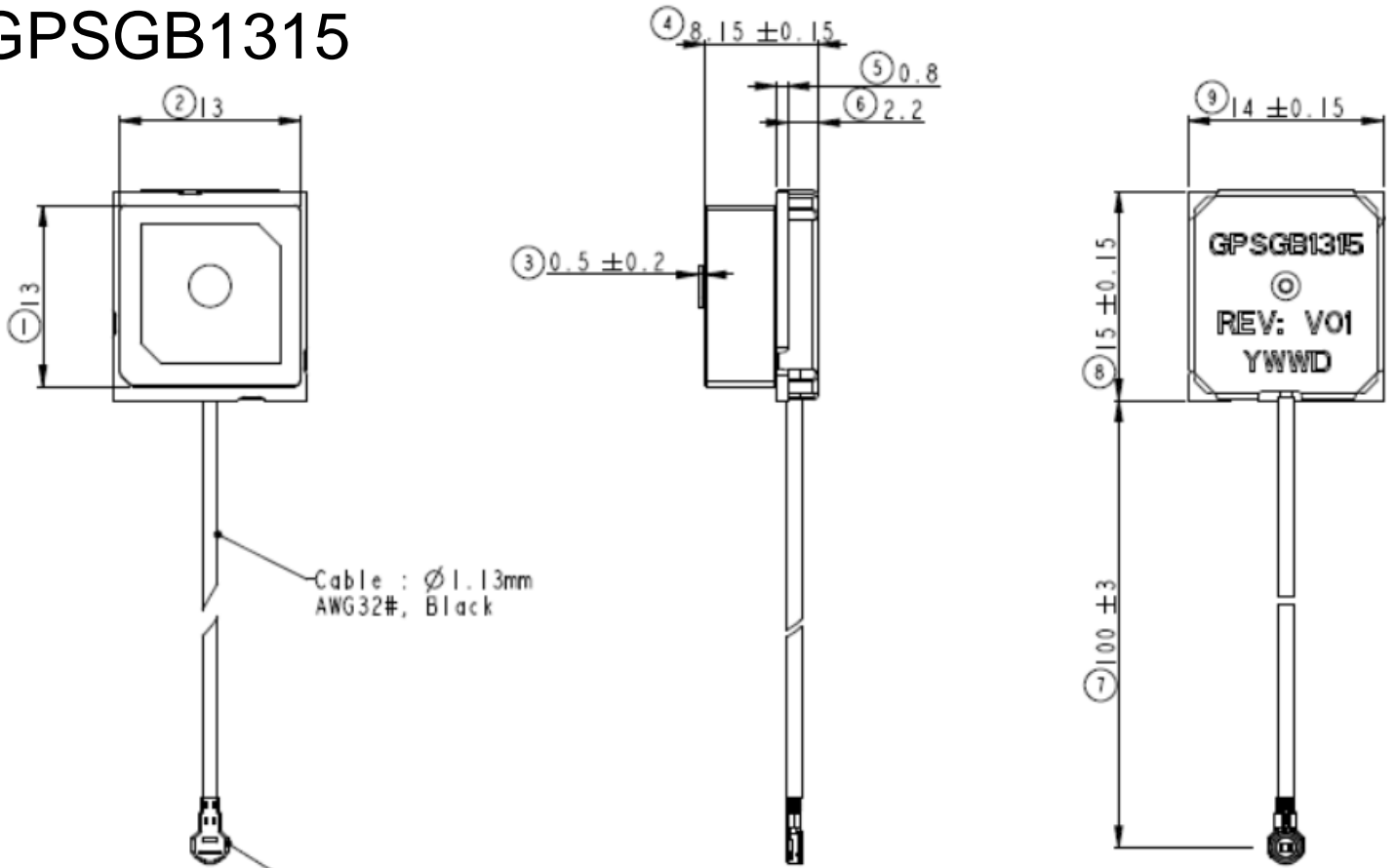

Suggested Receptacle: I-PEX 20279-001E-##
or I-PEX 20441-001E-01

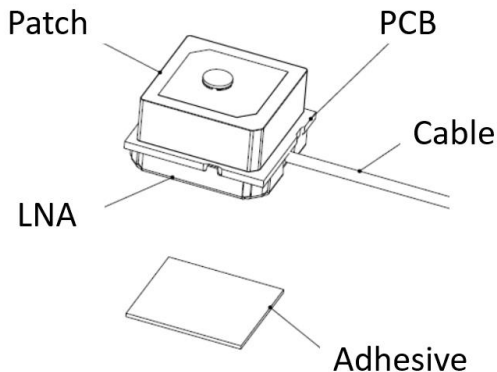

P.S.:

Adhesive tape material: 3M R16 , T=0.4mm

It's not assembled, but included in the sales package

Issue: 1626

In the effort to improve our products, we reserve the right to make changes judged to be necessary.

CONFIDENTIAL AND PROPRIETARY INFORMATION

This document contains confidential and proprietary information of Pulse Electronics, Inc. (Pulse) and is protected by copyright, trade secret and other state and federal laws. Its receipt or possession does not convey any rights to reproduce, disclose its contents, or to manufacture, use or sell anything it may describe. Reproduction, disclosure or use without specific written authorization of Pulse is strictly forbidden.

Series: Internal Active GPS

Description:

GPS/GLONASS/BEIDOU/COMPASS/Galileo

PART NUMBER: GPSGBXXXX

MECHANICAL DRAWING

GPSGB1330

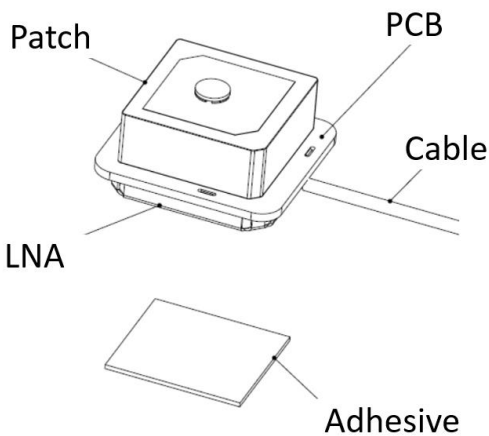
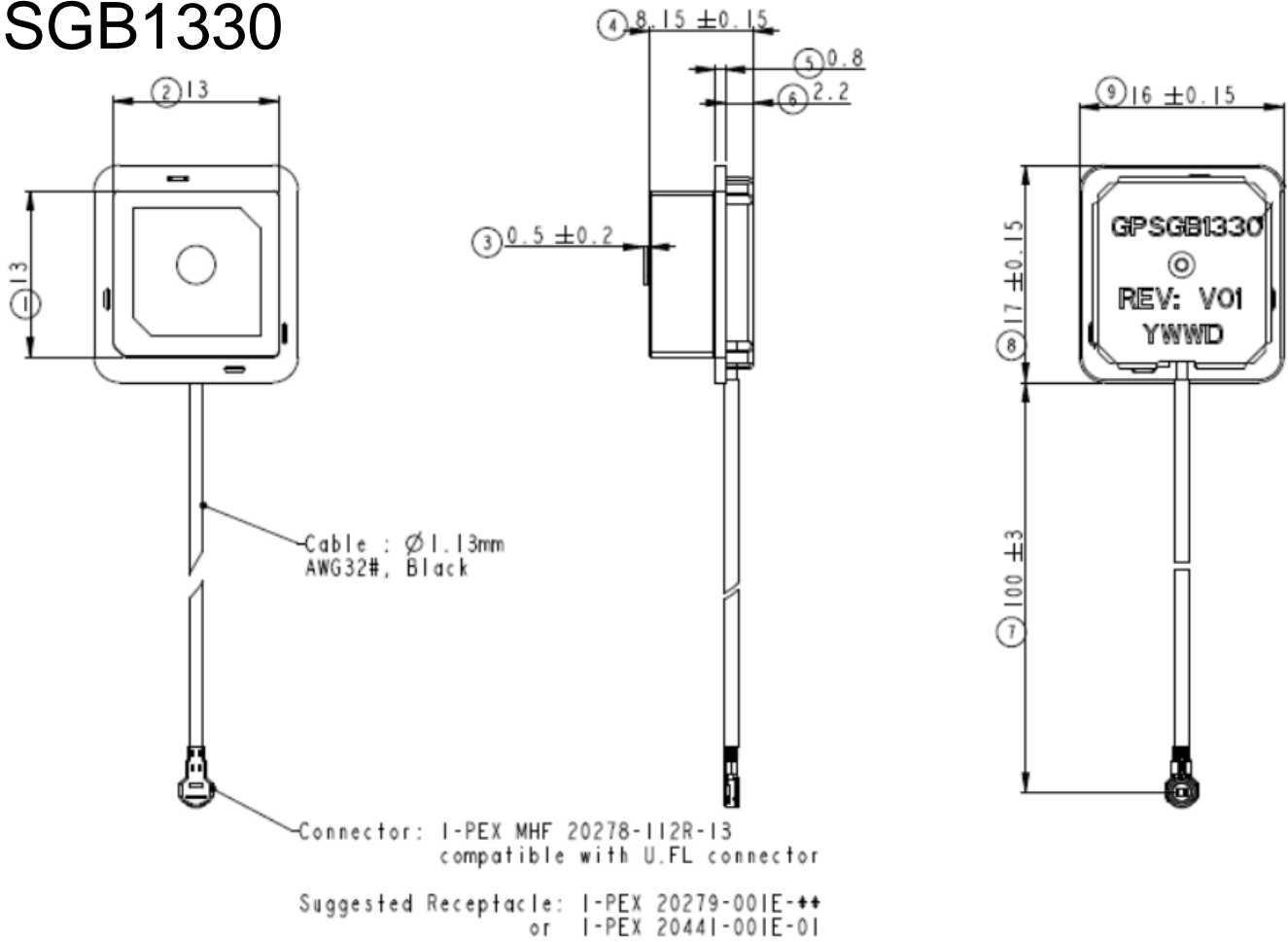

P.S.:

Adhesive tape material: 3M R16 , T=0.4mm

It's not assembled, but included in the sales package

Issue: 1626

In the effort to improve our products, we reserve the right to make changes judged to be necessary.

CONFIDENTIAL AND PROPRIETARY INFORMATION

This document contains confidential and proprietary information of Pulse Electronics, Inc. (Pulse) and is protected by copyright, trade secret and other state and federal laws. Its receipt or possession does not convey any rights to reproduce, disclose its contents, or to manufacture, use or sell anything it may describe. Reproduction, disclosure or use without specific written authorization of Pulse is strictly forbidden.

Description:

GPS/GLONASS/BEIDOU/COMPASS/Galileo

Series: Internal Active GPS

PART NUMBER: GPSGBXXXX

MECHANICAL DRAWING

GPSGB2515

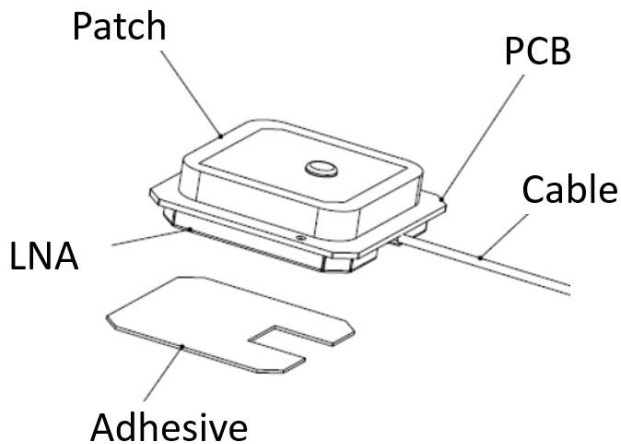
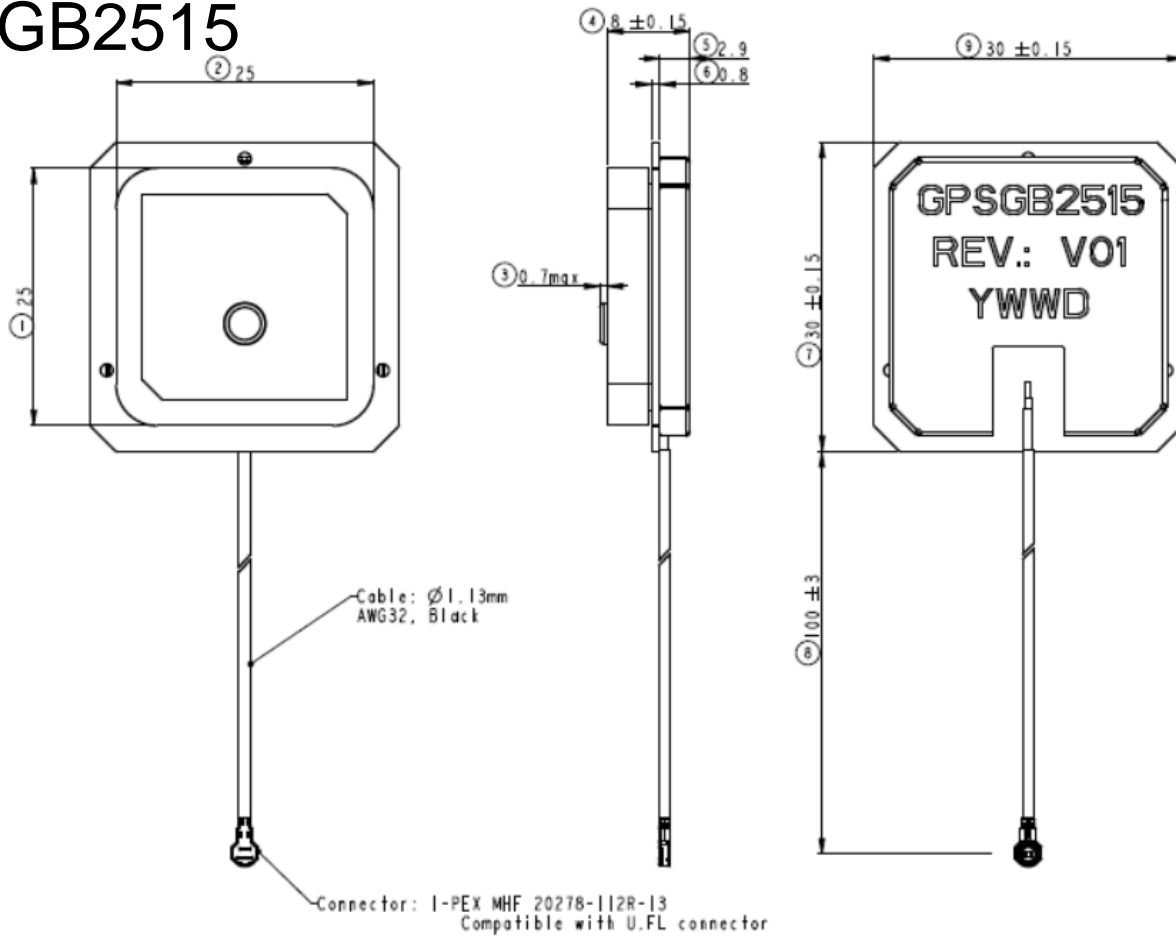

P.S.:

Adhesive tape material: 3M R16 , T=0.4mm
It's not assembled, but included in the sales package

Issue: 1626

In the effort to improve our products, we reserve the right to make changes judged to be necessary.

CONFIDENTIAL AND PROPRIETARY INFORMATION

This document contains confidential and proprietary information of Pulse Electronics, Inc. (Pulse) and is protected by copyright, trade secret and other state and federal laws. Its receipt or possession does not convey any rights to reproduce, disclose its contents, or to manufacture, use or sell anything it may describe. Reproduction, disclosure or use without specific written authorization of Pulse is strictly forbidden.

Series: Internal Active GPS

Description:

GPS/GLONASS/BEIDOU/COMPASS/Galileo

PART NUMBER: GPSGBXXXX

MECHANICAL DRAWING

GPSGB2530

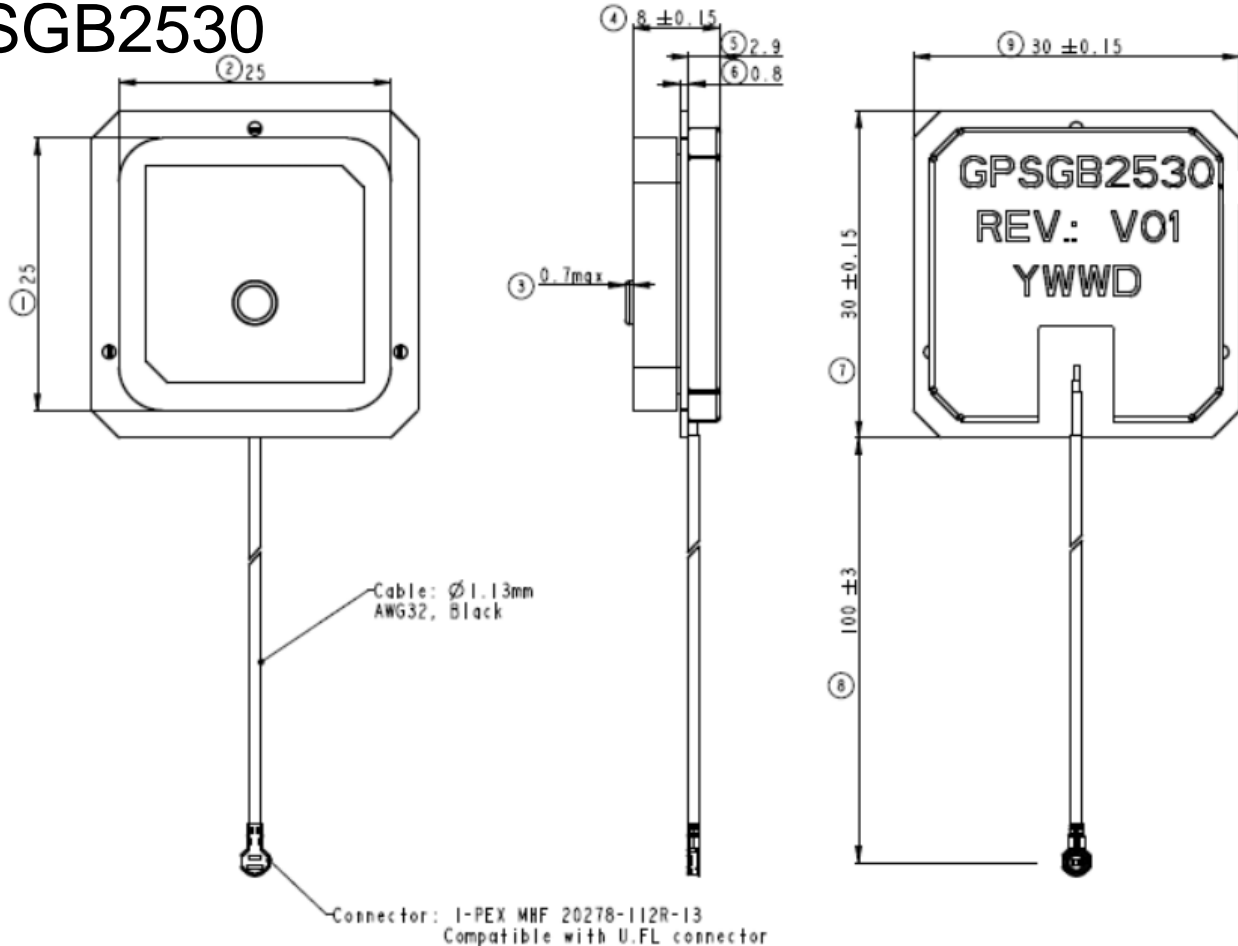

Suggested Receptacle: I-PEX 20279-001E-44
or I-PEX 20441-001E-01

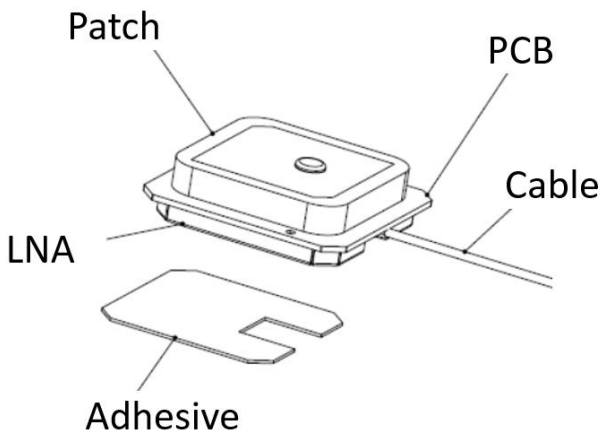

P.S.:

Adhesive tape material: 3M R16 , T=0.4mm

It's not assembled, but included in the sales package

Issue: 1626

In the effort to improve our products, we reserve the right to make changes judged to be necessary.

CONFIDENTIAL AND PROPRIETARY INFORMATION

This document contains confidential and proprietary information of Pulse Electronics, Inc. (Pulse) and is protected by copyright, trade secret and other state and federal laws. Its receipt or possession does not convey any rights to reproduce, disclose its contents, or to manufacture, use or sell anything it may describe. Reproduction, disclosure or use without specific written authorization of Pulse is strictly forbidden.

Series: Internal Active GPS

Description:

GPS/GLONASS/BEIDOU/COMPASS/Galileo

PART NUMBER: GPSGBXXXX

CHARTS

LNA Gain and out-of-band rejection

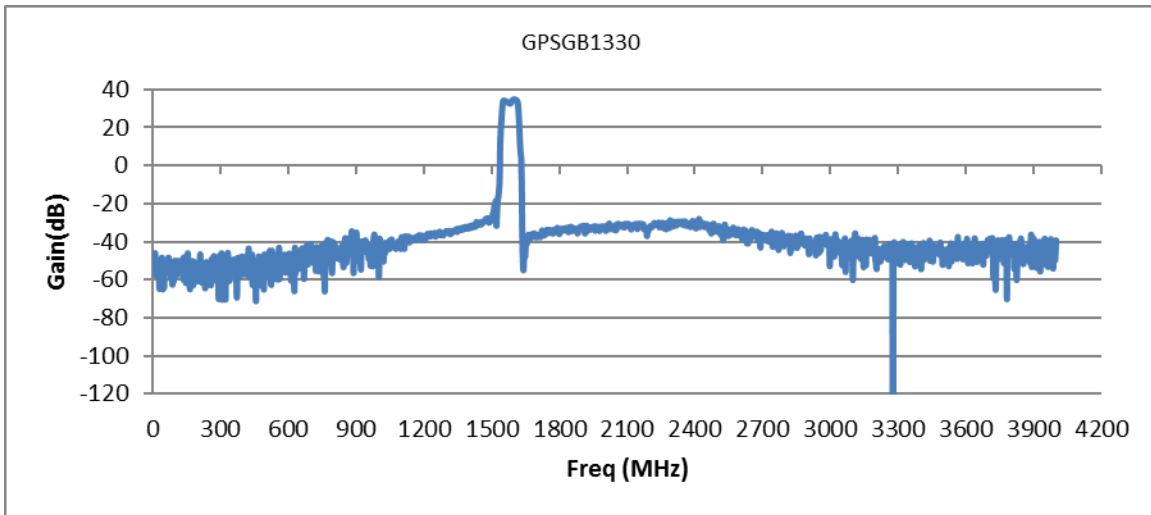
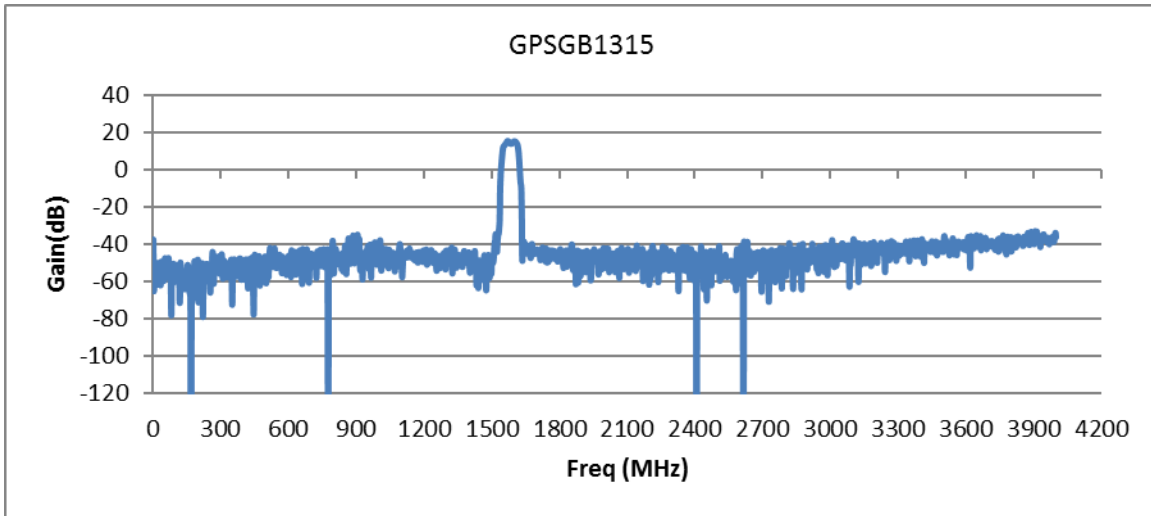

Issue: 1626

In the effort to improve our products, we reserve the right to make changes judged to be necessary.

CONFIDENTIAL AND PROPRIETARY INFORMATION

This document contains confidential and proprietary information of Pulse Electronics, Inc. (Pulse) and is protected by copyright, trade secret and other state and federal laws. Its receipt or possession does not convey any rights to reproduce, disclose its contents, or to manufacture, use or sell anything it may describe. Reproduction, disclosure or use without specific written authorization of Pulse is strictly forbidden.

Series: Internal Active GPS

Description:

GPS/GLONASS/BEIDOU/COMPASS/Galileo

PART NUMBER: GPSGBXXXX

CHARTS

LNA Gain and out-of-band rejection

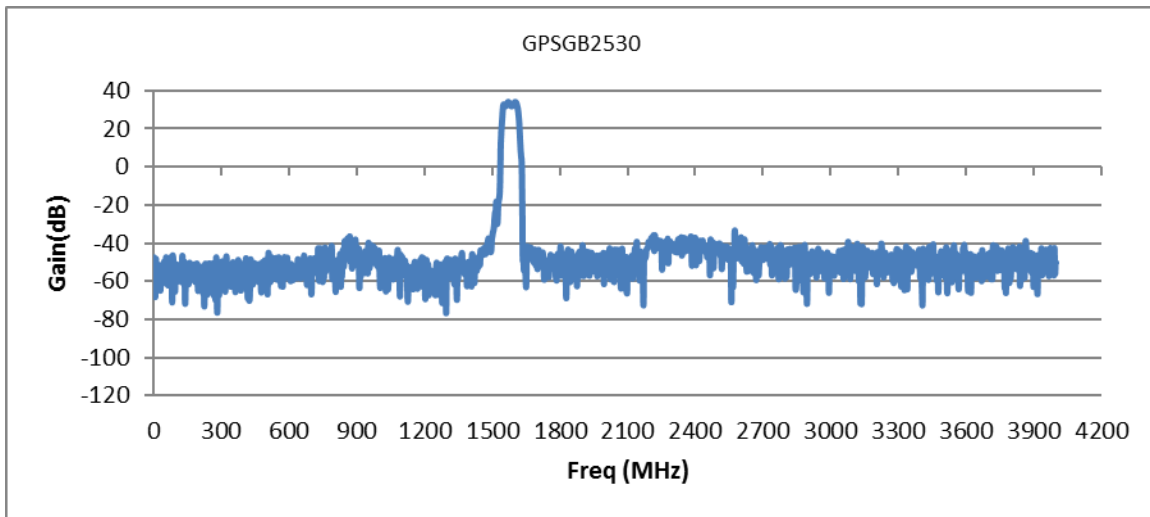
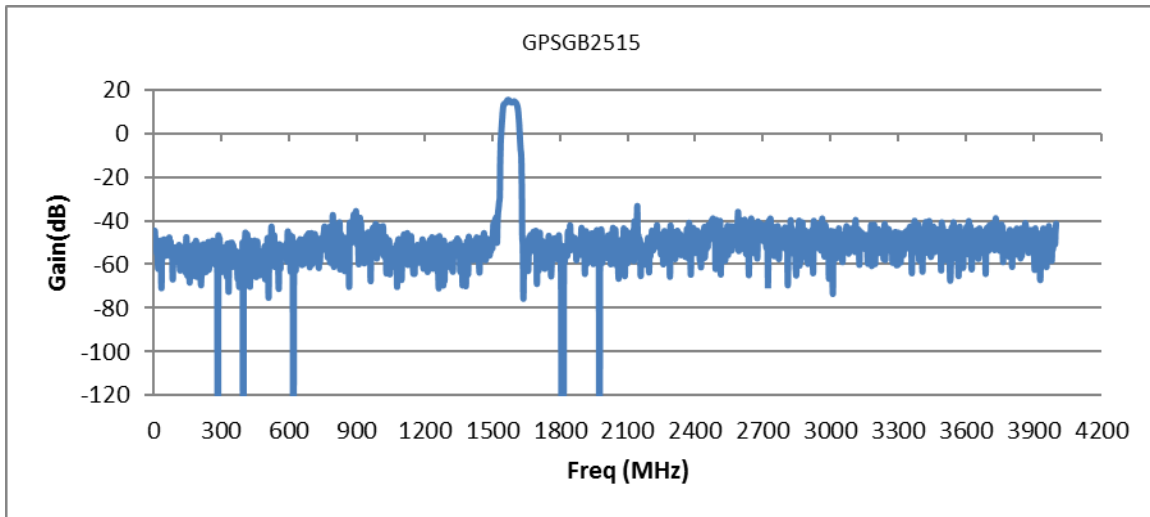

Issue: 1626

In the effort to improve our products, we reserve the right to make changes judged to be necessary.

CONFIDENTIAL AND PROPRIETARY INFORMATION

This document contains confidential and proprietary information of Pulse Electronics, Inc. (Pulse) and is protected by copyright, trade secret and other state and federal laws. Its receipt or possession does not convey any rights to reproduce, disclose its contents, or to manufacture, use or sell anything it may describe. Reproduction, disclosure or use without specific written authorization of Pulse is strictly forbidden.

Series: Internal Active GPS

Description:

GPS/GLONASS/BEIDOU/COMPASS/Galileo

PART NUMBER: GPSGBXXXX

CHARTS

Radiation Pattern (70mm x 70mm ground plane) GPS & Galileo

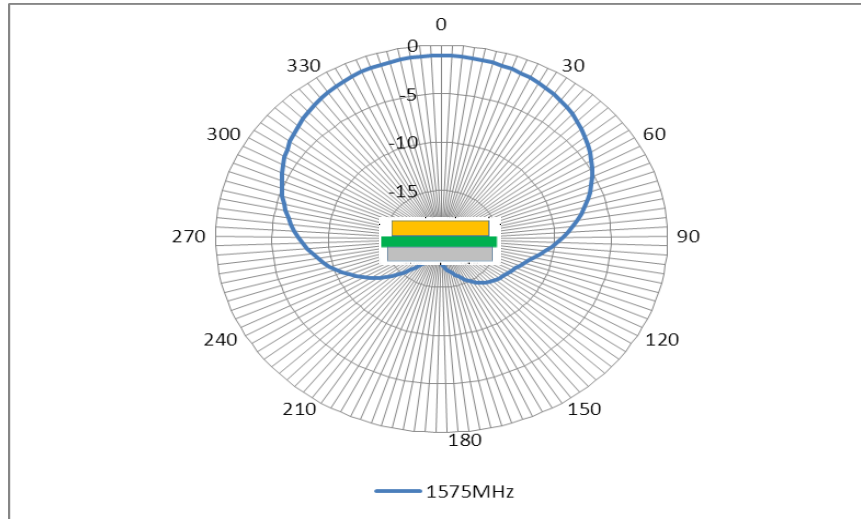

13 X 13 X 5mm Ceramic Antenna

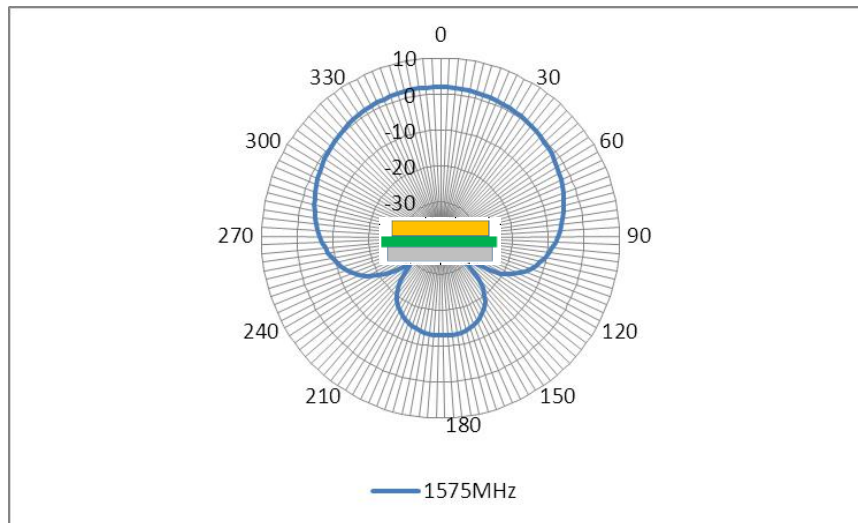

25 X 25 X 4mm Ceramic Antenna

Issue: 1626

In the effort to improve our products, we reserve the right to make changes judged to be necessary.

CONFIDENTIAL AND PROPRIETARY INFORMATION

This document contains confidential and proprietary information of Pulse Electronics, Inc. (Pulse) and is protected by copyright, trade secret and other state and federal laws. Its receipt or possession does not convey any rights to reproduce, disclose its contents, or to manufacture, use or sell anything it may describe. Reproduction, disclosure or use without specific written authorization of Pulse is strictly forbidden.

Series: Internal Active GPS

Description:

GPS/GLONASS/BEIDOU/COMPASS/Galileo

PART NUMBER: GPSGBXXXX

CHARTS

Radiation Pattern (70mm x 70mm ground plane) GLONASS

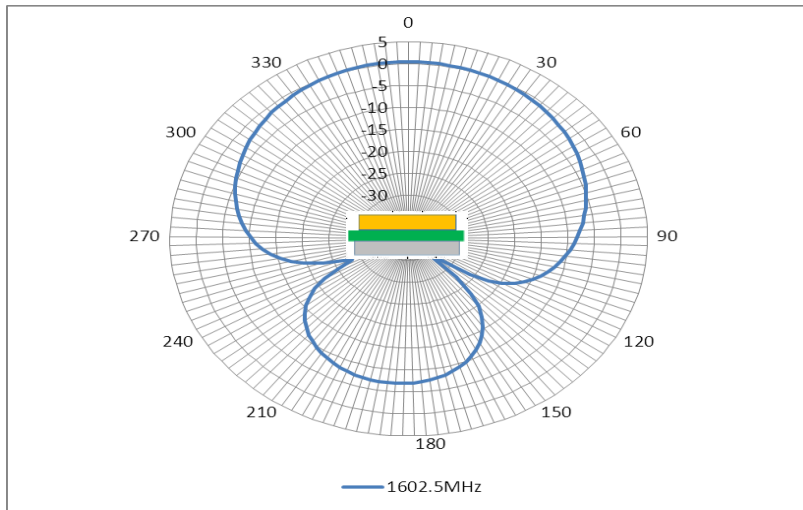

13 X 13 X 5mm Ceramic Antenna

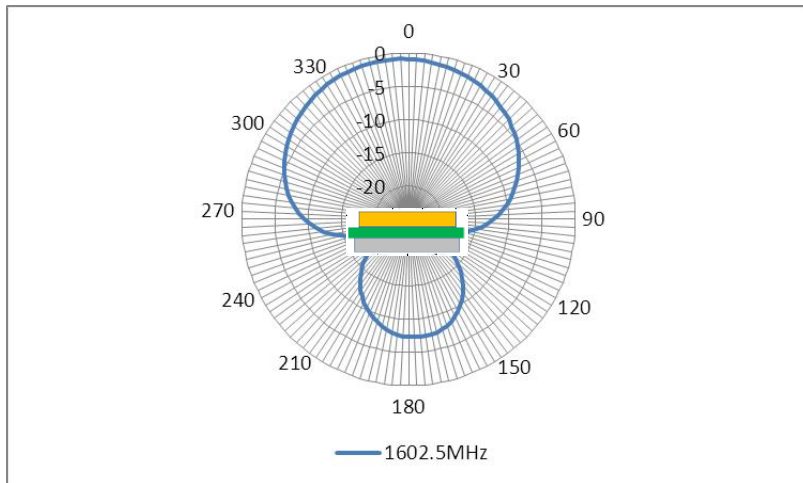

25 X 25 X 4mm Ceramic Antenna

Issue: 1626

In the effort to improve our products, we reserve the right to make changes judged to be necessary.

CONFIDENTIAL AND PROPRIETARY INFORMATION

This document contains confidential and proprietary information of Pulse Electronics, Inc. (Pulse) and is protected by copyright, trade secret and other state and federal laws. Its receipt or possession does not convey any rights to reproduce, disclose its contents, or to manufacture, use or sell anything it may describe. Reproduction, disclosure or use without specific written authorization of Pulse is strictly forbidden.

Series: Internal Active GPS

Description:

GPS/GLONASS/BEIDOU/COMPASS/Galileo

PART NUMBER: GPSGBXXXX

CHARTS

Radiation Pattern (70mm x 70mm ground plane) BD2

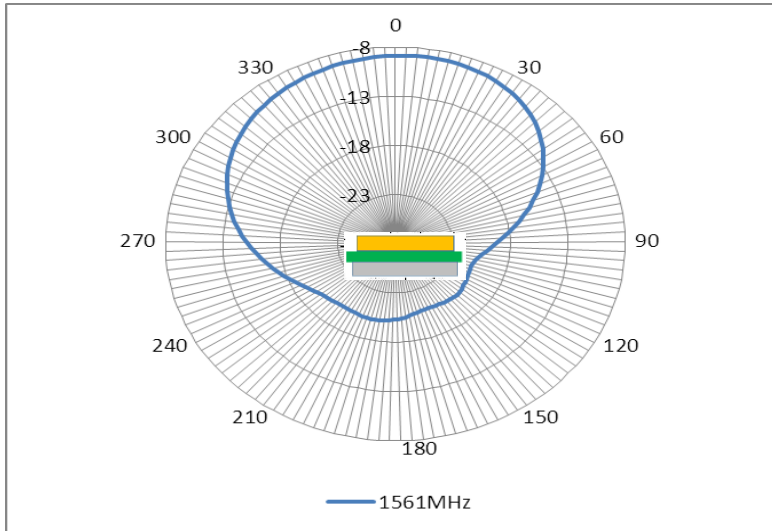

13 X 13 X 5mm Ceramic Antenna

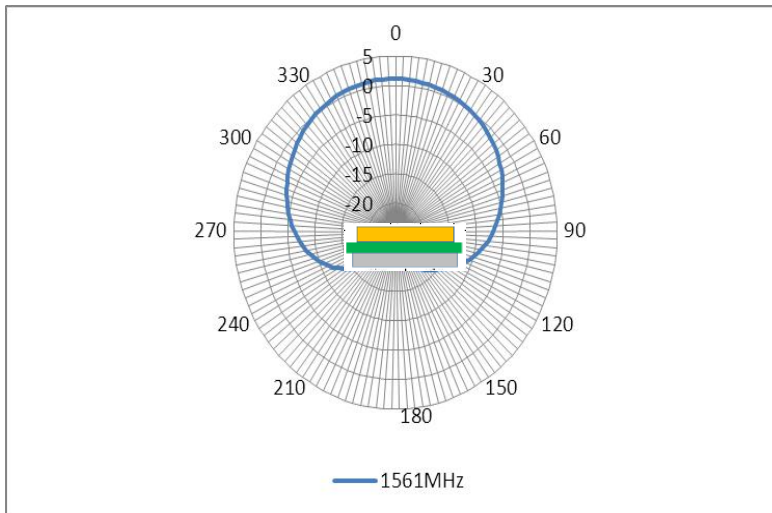

25 X 25 X 4mm Ceramic Antenna

Issue: 1626

In the effort to improve our products, we reserve the right to make changes judged to be necessary.

CONFIDENTIAL AND PROPRIETARY INFORMATION

This document contains confidential and proprietary information of Pulse Electronics, Inc. (Pulse) and is protected by copyright, trade secret and other state and federal laws. Its receipt or possession does not convey any rights to reproduce, disclose its contents, or to manufacture, use or sell anything it may describe. Reproduction, disclosure or use without specific written authorization of Pulse is strictly forbidden.