

#### PROTECTION PRODUCTS - RailClamp<sup>®</sup>

#### Description

RailClamp<sup>®</sup> TVS arrays are low capacitance ESD protection devices designed to protect high speed data interfaces. The RClamp<sup>®</sup>2654P provides dedicated surge and ESD protection for uUSB ports. It is designed to replace multiple discrete components in portable applications. This device features low capacitance TVS diodes for protection of the USB data (DP, DM) and USB ID pins operating up to 4 volts. These diodes provide ESD protection to  $\pm 15\text{kV}$  contact discharge per IEC 61000-4-2. Loading capacitance on these lines is  $<0.80\text{pF}$ . An integrated 26 volt TVS diode is used for protection of the USB voltage bus. The VBus TVS is designed with a high surge current capability of 80A (tp=8/20us) and low clamping voltage.

The RClamp2654P is in a 10-pin SLP2626P10 package. It measures 2.6 x 2.6mm with a nominal height of 0.60mm. This highly integrated device requires less board space than existing solutions.

The combination of small size, low capacitance, and high level of surge and ESD protection makes this device a flexible solution for protection of USB interfaces in mobile phones, laptops, and other portable electronics.

#### Features

- ◆ ESD and surge protection for USB Voltage Bus to **IEC 61000-4-2 (ESD)  $\pm 30\text{kV}$  (air),  $\pm 30\text{kV}$  (contact)**  
**IEC 61000-4-5 (Lightning) 80A (8/20 $\mu$ s)**  
**IEC 61000-4-4 (EFT) 40A (5/50ns)**
- ◆ ESD protection for USB data lines to **IEC 61000-4-2 (ESD)  $\pm 18\text{kV}$  (air),  $\pm 15\text{kV}$  (contact)**
- ◆ Protects USB DP, DM, and ID Pin operating to 4V
- ◆ Protects USB VBus operating up to 26V
- ◆ Low capacitance ( **$<0.80\text{pF}$** ) on DP, DM, and ID Pins
- ◆ Low clamping voltage
- ◆ Extremely low dynamic resistance: 0.55 Ohms (Typ) on DP, DM, and ID Pins
- ◆ Solid-state silicon-avalanche technology

#### Mechanical Characteristics

- ◆ SLP2626P10 10L package
- ◆ Pb-Free, Halogen Free, RoHS/WEEE Compliant
- ◆ Nominal Dimensions: 2.6 x 2.6 x 0.60 mm
- ◆ Lead Finish: NiPdAu
- ◆ Molding compound flammability rating: UL 94V-0
- ◆ Marking : Marking Code + Date Code
- ◆ Packaging : Tape and Reel

#### Applications

- ◆ USB 2.0
- ◆ USB OTG
- ◆ uUSB

#### Circuit Diagram

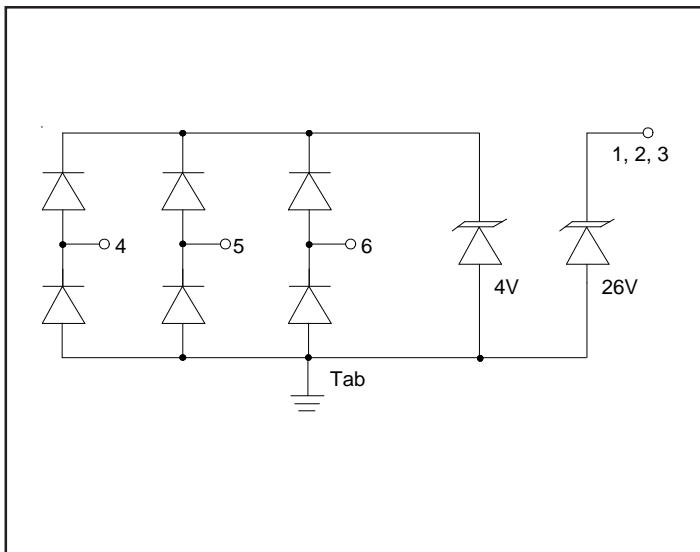

#### Pin Configuration (Top View)

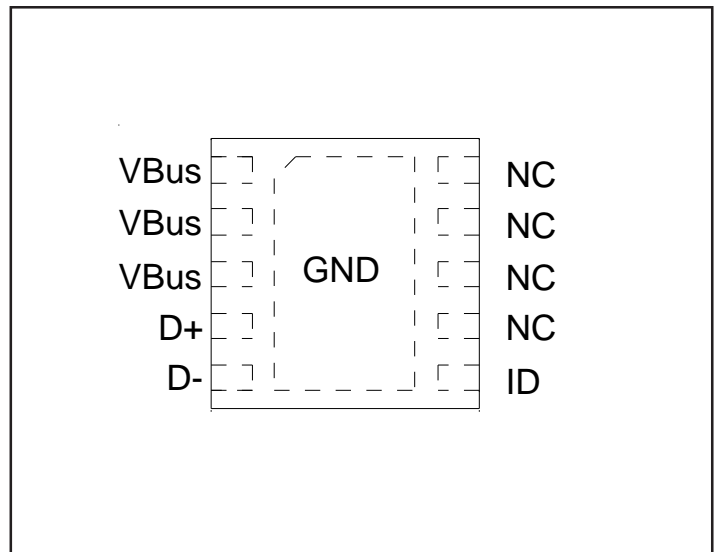

**PROTECTION PRODUCTS**
**Absolute Maximum Rating**

Rating	Symbol	Value	Units
<b>DP, DM, USB ID TVS</b>			
Peak Pulse Power (tp = 8/20μs)	$P_{pk}$	40	Watts
Peak Pulse Current (tp = 8/20μs)	$I_{pp}$	4	A
ESD per IEC 61000-4-2 (Air) ESD per IEC 61000-4-2 (Contact)	$V_{ESD}$	±18 ±15	kV
Operating Temperature	$T_j$	-40 to +85	°C
Storage Temperature	$T_{STG}$	-55 to +150	°C
<b>VBus TVS</b>			
Peak Pulse Power (tp = 8/20μs)	$P_{pk}$	4000	Watts
Peak Pulse Current (tp = 8/20μs)	$I_{pp}$	80	A
ESD per IEC 61000-4-2 (Air) ESD per IEC 61000-4-2 (Contact)	$V_{ESD}$	±30 ±30	kV
Operating Temperature	$T_j$	-40 to +85	°C
Storage Temperature	$T_{STG}$	-55 to +150	°C

**Electrical Characteristics (T=25°C Unless Otherwise Specified)**

<b>VBus TVS (Pin 1, 2, 3)</b>						
Parameter	Symbol	Conditions	Minimum	Typical	Maximum	Units
Reverse Stand-Off Voltage	$V_{RWM}$	Pin 1 to GND			26	V
Reverse Breakdown Voltage	$V_{BR}$	$I_t = 1mA$ , Pin 1 to GND	28	29.5	33	V
Reverse Leakage Current	$I_R$	$V_{RWM} = 26V$ Pin 1 to GND		<0.010	0.100	μA
Forward Voltage	$V_F$	$I_f = 10mA$ GND to Pin 1	0.6	0.7	1.0	V
Clamping Voltage	$V_C$	$I_{pp} = 10A$ , tp = 8/20μs Pin 1 to Ground			35	V
Clamping Voltage	$V_C$	$I_{pp} = 58A$ , tp = 8/20μs Pin 1 to Ground		39	43	V
Junction Capacitance	$C_j$	$V_R = 0V$ , f = 1MHz Pin 1 to GND		620	750	pF

**PROTECTION PRODUCTS**
**Electrical Characteristics (T=25°C Unless Otherwise Specified)**

DM, DP, USB ID (Pins 4, 5, 6)						
Parameter	Symbol	Conditions	Minimum	Typical	Maximum	Units
Reverse Stand-Off Voltage	$V_{RWM}$	Pin 4, 5, or 6 to GND			4	V
Reverse Breakdown Voltage	$V_{BR}$	$I_t = 2\mu A$ , Pin 4, 5, or 6 to GND	4.2	4.5	5.3	V
Reverse Leakage Current	$I_R$	$V_{RWM} = 2.0V$ , Pin 4, 5, or 6 to GND		<0.005	0.020	$\mu A$
Reverse Leakage Current	$I_R$	$V_{RWM} = 4.0V$ , Pin 4, 5, or 6 to GND		<0.010	0.100	$\mu A$
Forward Voltage	$V_F$	$I_f = 15mA$ Pin 4, 5, or 6 to GND	0.6		1.2	V
Clamping Voltage	$V_C$	$I_{pp} = 1A$ , $t_p = 8/20\mu s$ Pin 4, 5, or 6 to GND			8.5	V
Clamping Voltage	$V_C$	$I_{pp} = 4A$ , $t_p = 8/20\mu s$ Pin 4, 5, or 6 to GND			10	V
Dynamic Resistance <sup>1</sup>	$R_{Dyn}$	$I_{pp} = 4A$ to $I_{pp} = 16A$		0.55		Ohms
		$I_{pp} = -4A$ to $I_{pp} = -16A$		0.35		Ohms
Junction Capacitance	$C_j$	$V_R = 0V$ , $f = 1MHz$ , Pin 4, 5, or 6 to GND		0.6	0.80	pF
		$V_R = 0V$ , $f = 1MHz$ , Between I/O pins			0.4	pF

**Notes**

1)Transmission Line Pulse Test (TLP) Settings:  $t_p = 100ns$ ,  $t_r = 0.2ns$ ,  $I_{TLP}$  and  $V_{TLP}$  averaging window:  $t_1 = 70ns$  to  $t_2 = 90ns$

**PROTECTION PRODUCTS**

Typical Characteristics (T=25°C Unless Otherwise Specified)

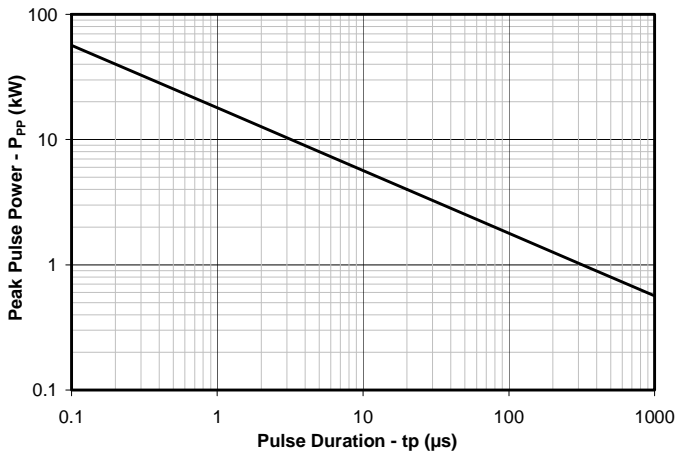
**Non-Repetitive Peak Pulse Power vs. Pulse Time  
VBus Pins (Pins 1, 2, 3) Shorted Together**

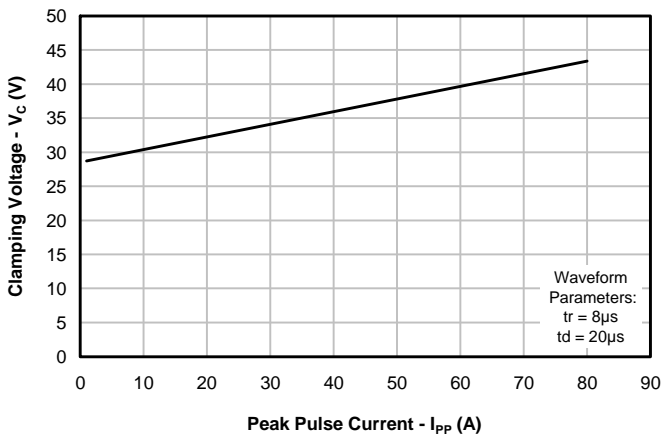
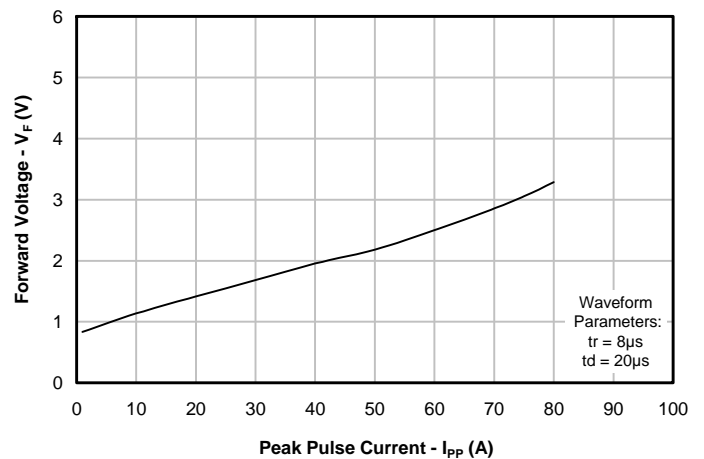
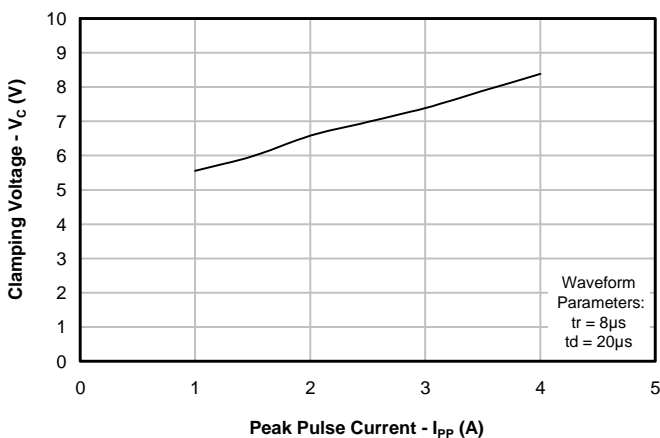
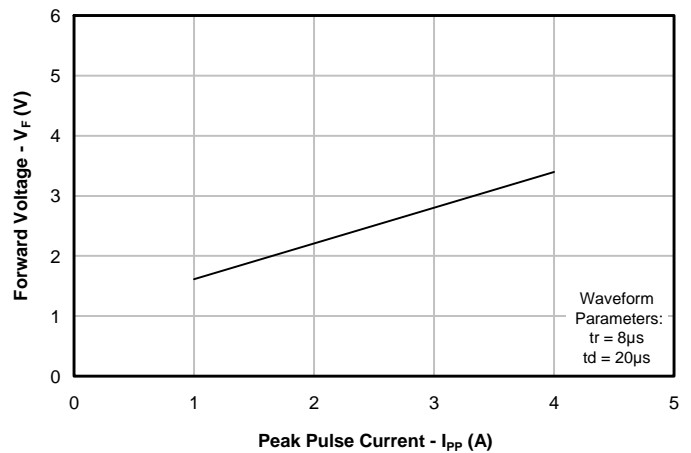
**Non-Repetitive Peak Pulse Power vs. Pulse Time  
D+, D-, ID Pins (Pins 4, 5, 6)**

**Clamping Voltage vs. Peak Pulse Current  
VBus Pins (Pins 1, 2, 3) Shorted Together**

**Forward Voltage vs. Peak Pulse Current  
VBus Pins (Pins 1, 2, 3) Shorted Together**

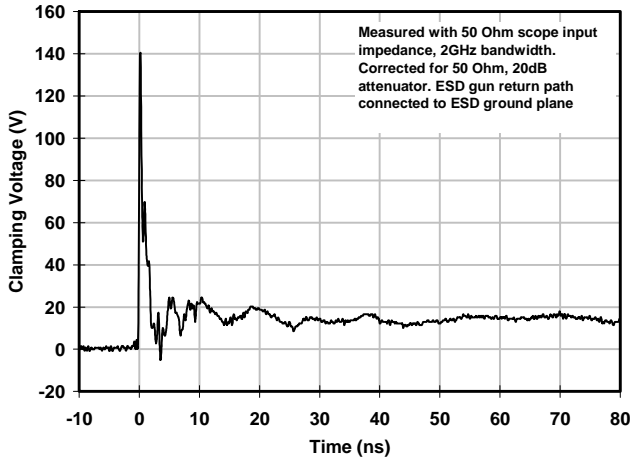
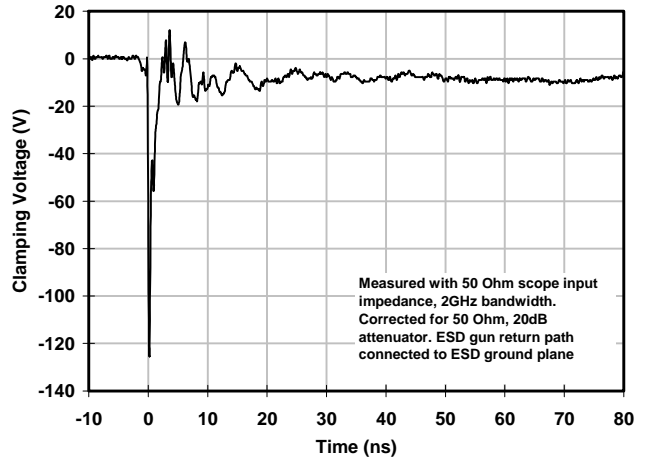
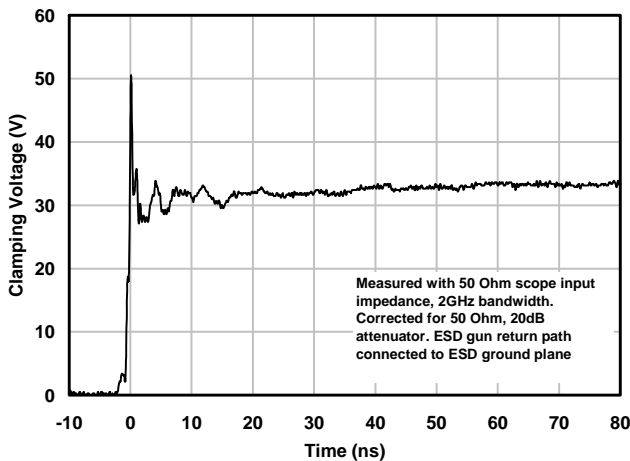
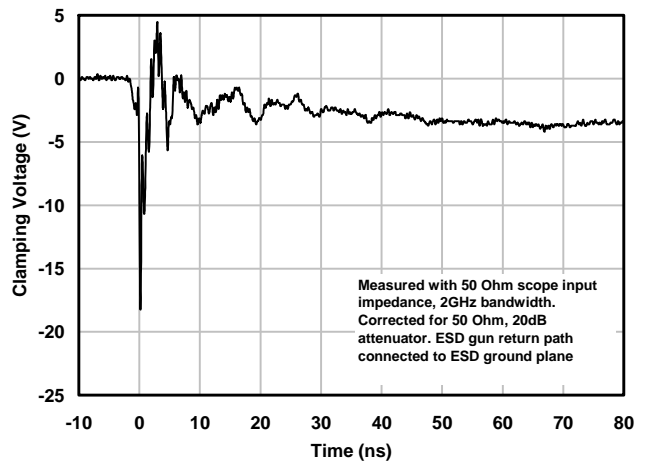
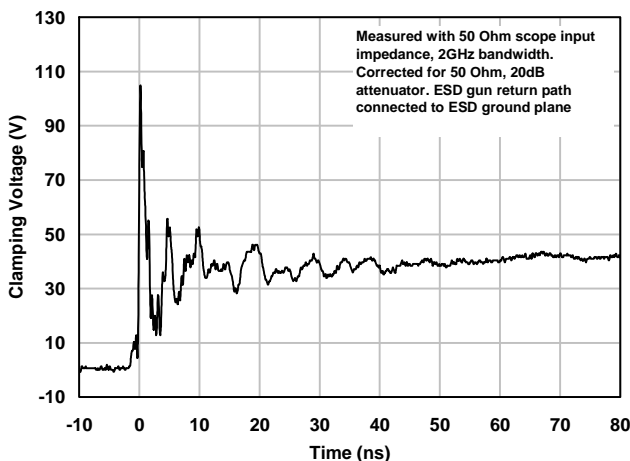
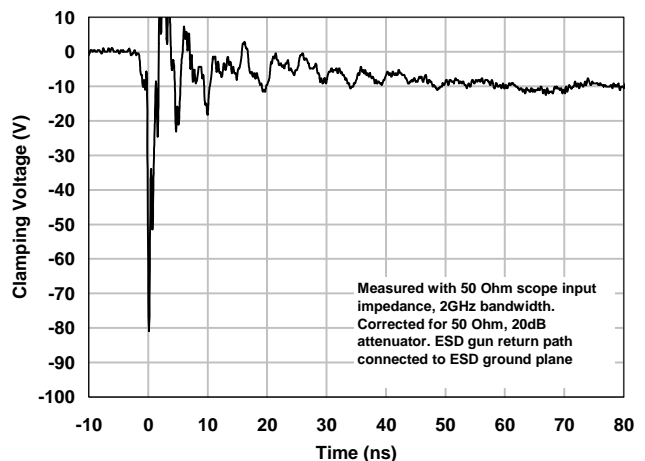
**Clamping Voltage vs. Peak Pulse Current  
D+, D-, ID Pins (Pins 4, 5, 6)**

**Forward Voltage vs. Peak Pulse Current  
D+, D-, ID Pins (Pins 4, 5, 6)**

**PROTECTION PRODUCTS**

Typical Characteristics (T=25°C Unless Otherwise Specified)

**ESD Clamping (+8kV Contact per IEC 61000-4-2)  
D+, D-, ID Pins (Pins 4, 5, 6)**

**ESD Clamping (-8kV Contact per IEC 61000-4-2)  
D+, D-, ID Pins (Pins 4, 5, 6)**

**ESD Clamping (+8kV Contact per IEC 61000-4-2)  
VBus Pins (Pins 1, 2, 3)**

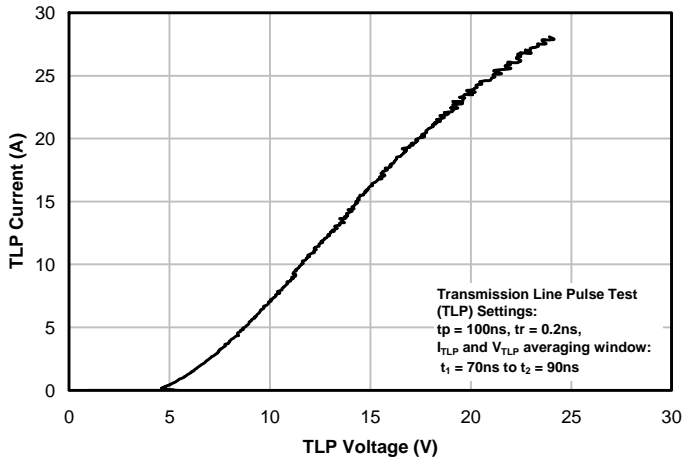
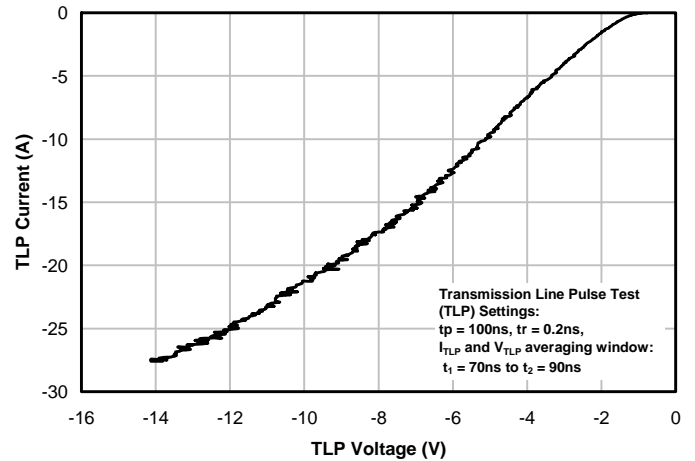
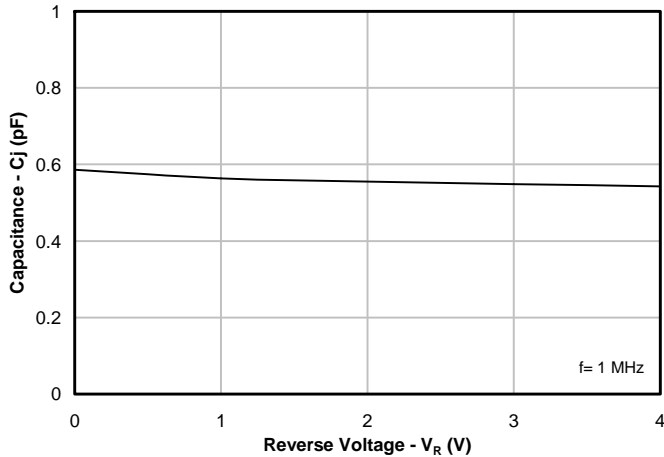
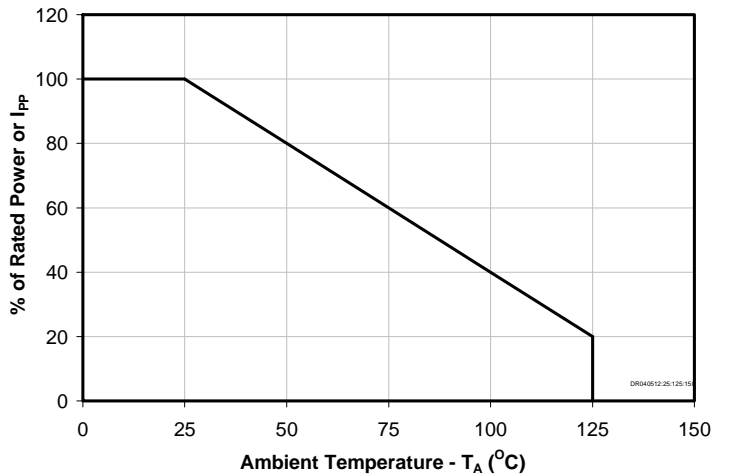
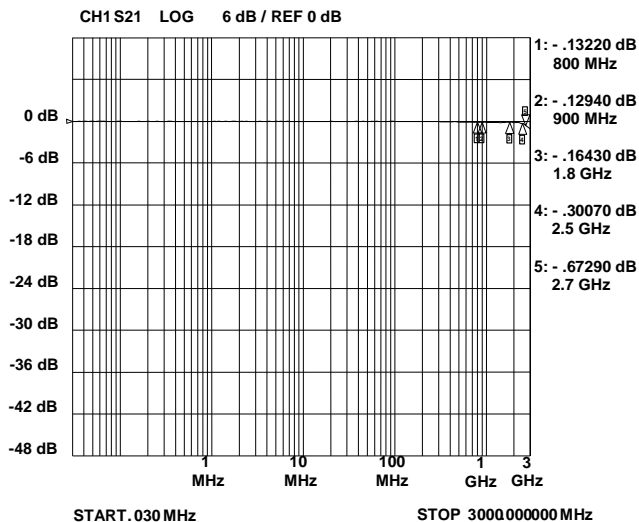
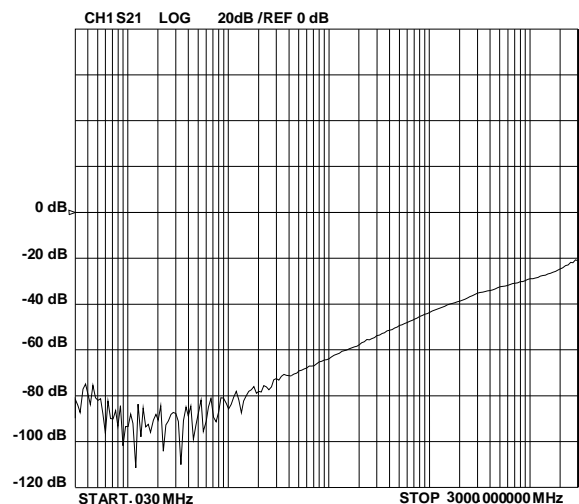
**ESD Clamping (-8kV Contact per IEC 61000-4-2)  
VBus Pins (Pins 1, 2, 3)**

**ESD Clamping +30kV Contact per IEC 61000-4-2)  
VBus Pins (Pins 1, 2, 3)**

**ESD Clamping -30kV Contact per IEC 61000-4-2)  
VBus Pins (Pins 1, 2, 3)**

**PROTECTION PRODUCTS**

Typical Characteristics (T=25°C Unless Otherwise Specified)

**TLP Characteristic (Positive Pulse)**  
**D+, D-, ID Pins (Pins 4, 5, 6)**

**TLP Characteristic (Negative Pulse)**  
**D+, D-, ID Pins (Pins 4, 5, 6)**

**Capacitance vs. Reverse Voltage**  
**D+, D-, ID Pins (Pins 4, 5, 6)**

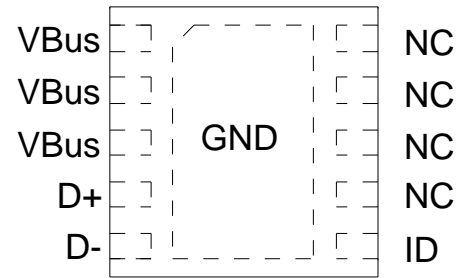
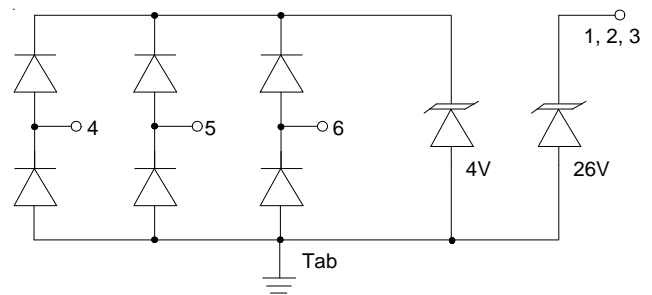
**Non-Repetitive Peak Pulse Power Derating Curve**

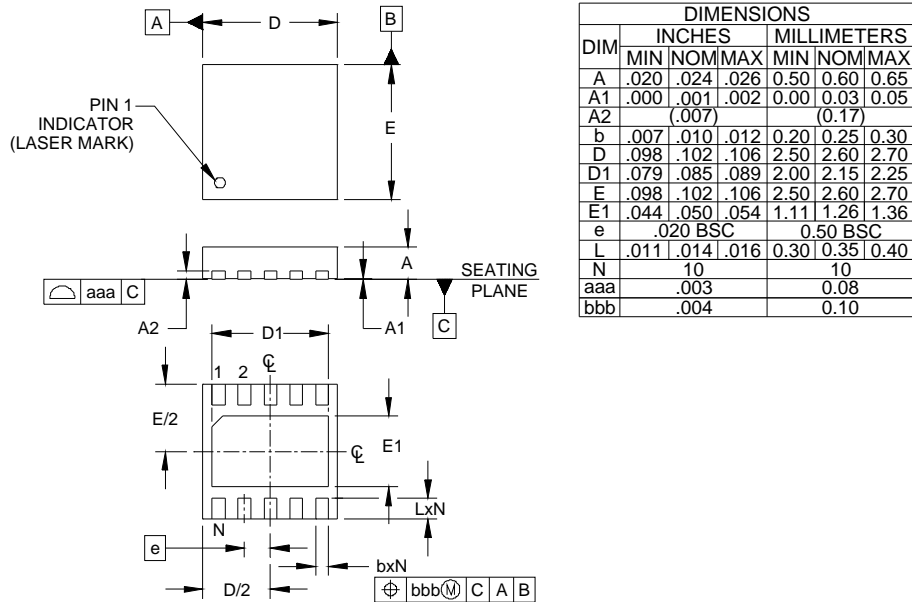
**Typical Insertion Loss S21**  
**D+, D-, ID Pins (Pins 4, 5, 6)**

**Analog Crosstalk**  
**D+, D-, ID Pins (Pins 4, 5, 6)**

**PROTECTION PRODUCTS**
**Applications Information**
**Device Connection and Layout Options for Protecting One USB Port**

The RClamp2654P is optimized for protection of USB ports. Low capacitance protection is provided for the USB data (DM, DP) and USB ID lines at pins 4, 5, and 6. These inputs are referenced to an internal 4 volt TVS protection device. When the voltage on these lines exceed 4 volts, the TVS will conduct. Pins 1, 2, and 3 are connected to the USB voltage bus (VBus). These three pins must be shorted together on the PCB otherwise the maximum surge capability of the device will be reduced. The VBus TVS has a minimum breakdown voltage of 28V at 1mA. Ground is provided at the center tab. Multiple micro vias connected to ground are recommended for best ESD performance. This will reduce parasitic inductance in the ground path and minimize the clamping voltage seen by the protected device.

**Figure 1 - Pin Configuration (Top View)**

**Figure 2 - RClamp2654P Schematic**

**PROTECTION PRODUCTS**
**Outline Drawing - SLP2626P10**

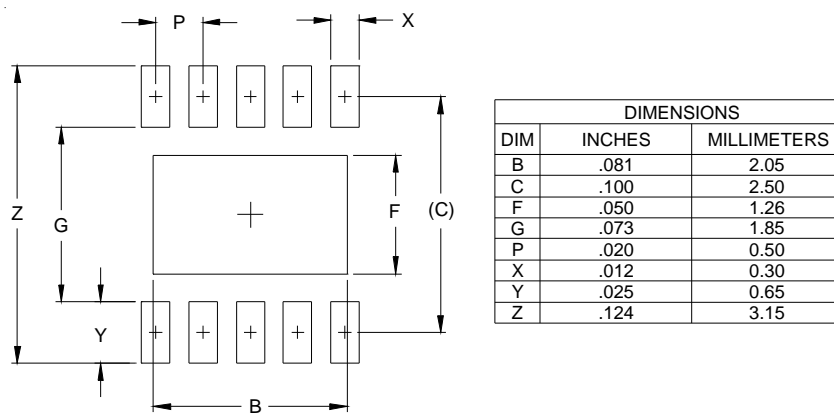
**NOTES:**

1. CONTROLLING DIMENSIONS ARE IN MILLIMETERS (ANGLES IN DEGREES).
2. COPLANARITY APPLIES TO THE EXPOSED PAD AS WELL AS THE TERMINALS.

**Land Pattern - SLP2626P10**

**NOTES:**

1. THIS LAND PATTERN IS FOR REFERENCE PURPOSES ONLY. CONSULT YOUR MANUFACTURING GROUP TO ENSURE YOUR COMPANY'S MANUFACTURING GUIDELINES ARE MET.

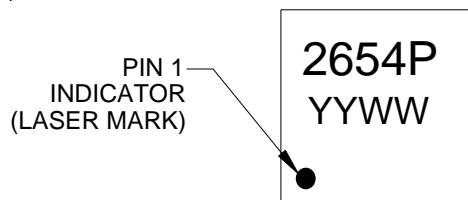

## PROTECTION PRODUCTS

### Marking Codes



YYWW = Date Code

### Ordering Information

Part Number	Qty per Reel	Reel Size
RClamp2654P.TCT	3,000	7 Inch

RClamp and RClamp are trademarks of Semtech Corporation.

### Carrier Tape Specification

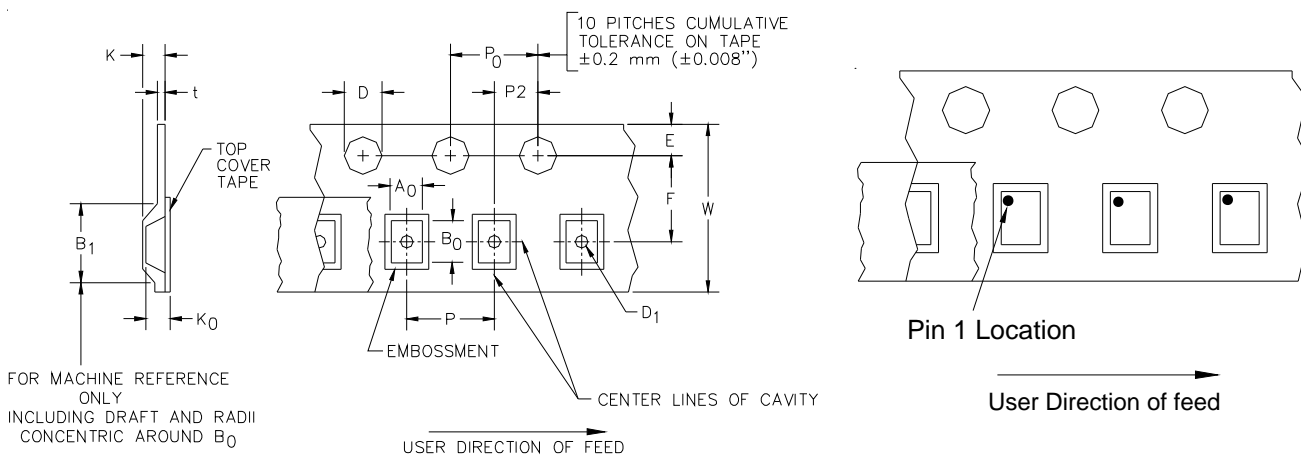

A0	B0	K0
2.77 +/-0.10 mm	2.77 +/-0.10 mm	0.80 +/-0.10 mm

Tape Width	B, (Max)	D	D1	E	F	K (MAX)	P	P0	P2	T(MAX)	W
8 mm	4.2 mm (.165)	1.5 + 0.1 mm - 0.0 mm	1.0 mm ±0.05	1.750±.10 mm	3.5±0.05 mm	2.4 mm	4.0±0.1 mm	4.0±0.1 mm	2.0±0.05 mm	0.4 mm	8.0 mm + 0.3 mm - 0.1 mm

### Contact Information

Semtech Corporation  
 Protection Products Division  
 200 Flynn Road, Camarillo, CA 93012  
 Phone: (805)498-2111 FAX (805)498-3804