

# Multiband Antenna Module

**APAMPSLJ-140**

RoHS/RoHS II compliant



196.0 X 38.0 X 13.8mm

MSL level: Not Applicable

## FEATURES:

- Passive Multiband Blade Antenna (699MHz ~ 2690MHz)
- Covering Cellular + 3G + 4G + Cellular + GPS & GLONASS + WiFi/Bluetooth + LTE 2.6GHz
- Internal Router Blade design
- Gain (3dBi) Typ
- VSWR 2:1 (GPS), 4:1 (2.5 ~ 2.6GHz), 5:1 2.5 ~ 2.69GHz
- Dimensions (171 x 38 x 13.8mm)
- Linear Polarization
- SMA Male connector
- RoHS/RoHS II compliant
- 2J Technology

## TYPICAL APPLICATIONS:

- Terminal Antenna for 2G / 3G / 4G and Cellular Gateways + WiFi.
- Wireless Routers
- LTE

## STANDARD SPECIFICATIONS:

Parameters	Min.	Typ.	Max.	Units	Note
Receiving Frequency	1559		1606	MHz	GPS/GLONASS/Galileo
	699		960	MHz	4G/LTE
	1710		2690	MHz	4G/LTE
VSWR			2:1		GPS
			4:1		@ 699-2600MHz
			5:1		@ 2500-2690MHz
Polarization Model	Linear				
Impedance		50		$\Omega$	
Gain		3.0		dBi	
Operating Temperature	-40		+85	$^{\circ}\text{C}$	

## MEASUREMENTS - 3D SPHERICAL

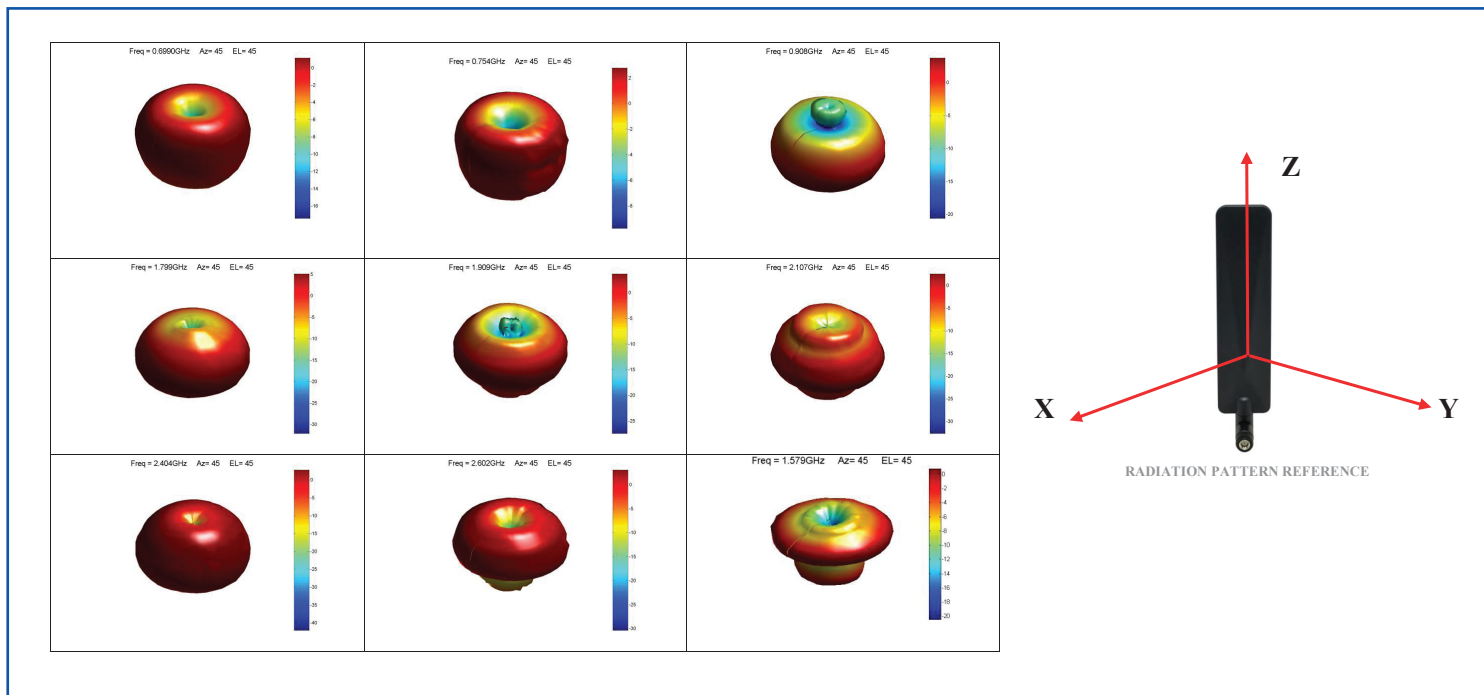

ABRACON IS  
ISO9001:2008  
CERTIFIED

**ABRACON**<sup>®</sup>  
The Power of Linking Together

2 Faraday, Suite# B | Irvine | CA 92618 **Revised: 06.11.15**  
Ph. 949.546.8000 | Fax. 949.546.8001  
Visit [www.abracon.com](http://www.abracon.com) for Terms and Conditions of Sale

# Multiband Antenna Module

APAMPSLJ-140

RoHS/RoHS II compliant



196.0 X 38.0 X 13.8mm

## S11

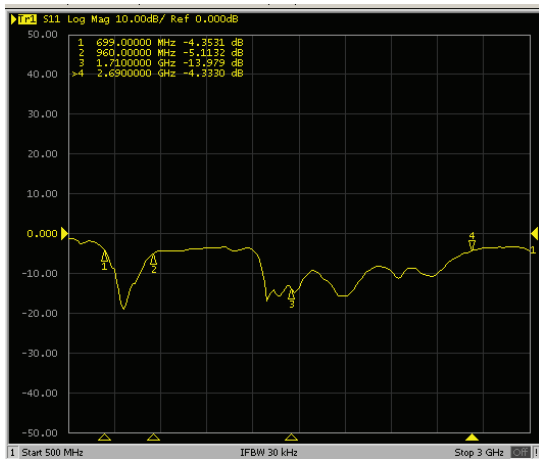

Figure 1 - Log Mag at 0deg

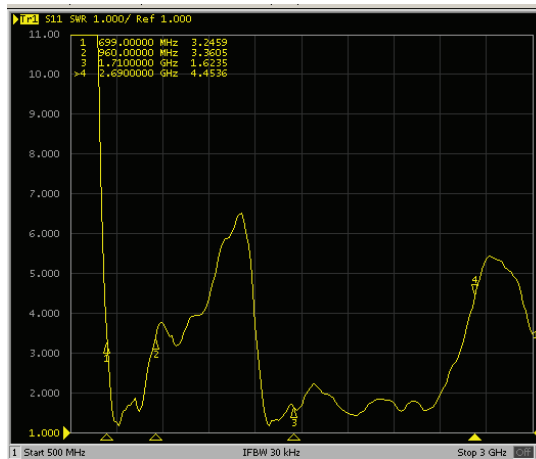

Figure 2 - VSWR at 0deg

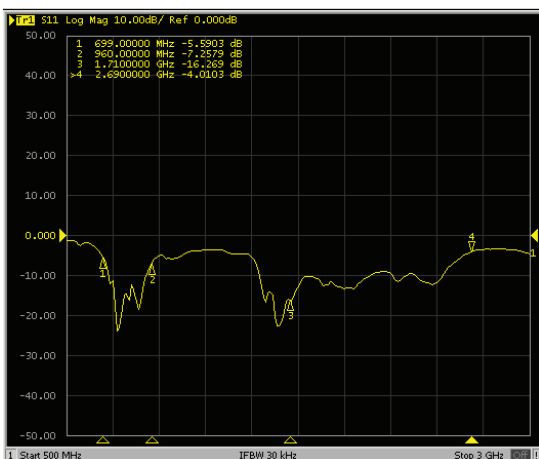

Figure 3 - Log Mag at 45deg

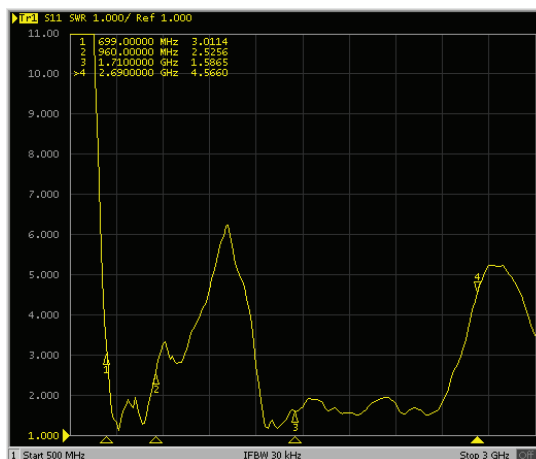

Figure 4 - VSWR at 45deg

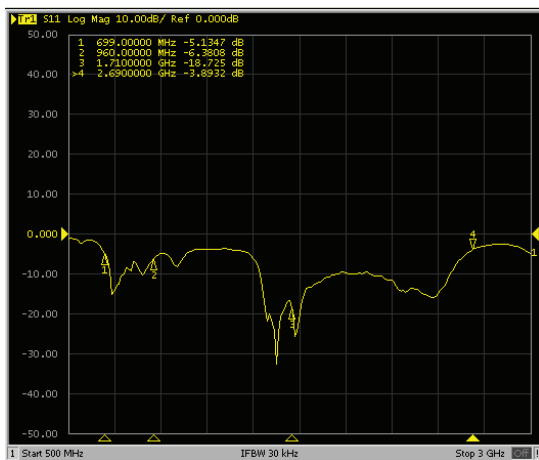

Figure 5 - Log Mag at 90deg

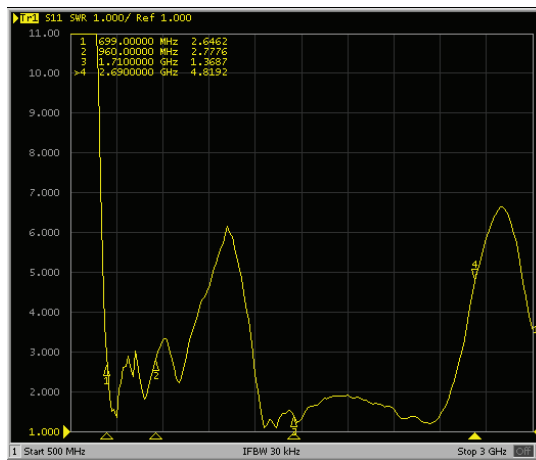

Figure 6 - VSWR at 90deg

# Multiband Antenna Module

APAMPSLJ-140

RoHS/RoHS II compliant



196.0 X 38.0 X 13.8mm

S11

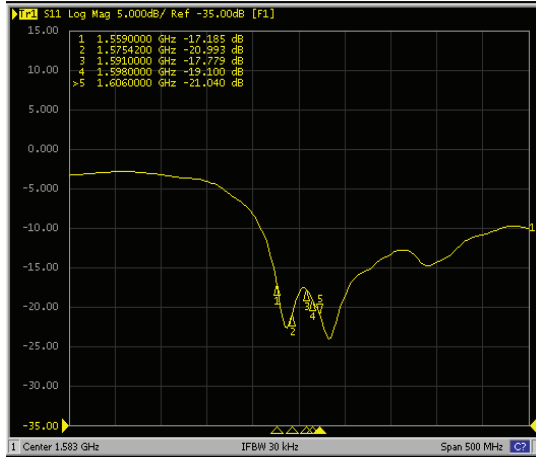

Figure 7 - Log Mag at 0deg

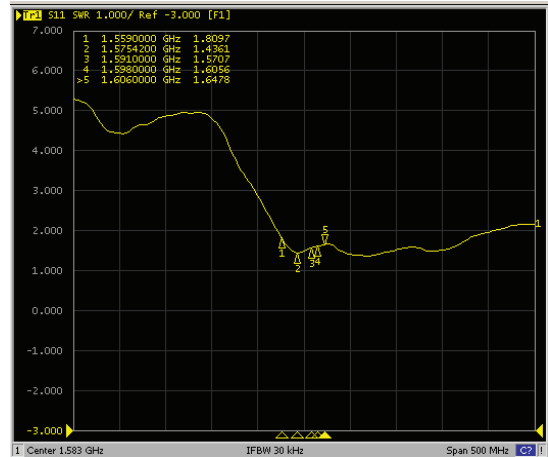

Figure 8 - VSWR at 0deg

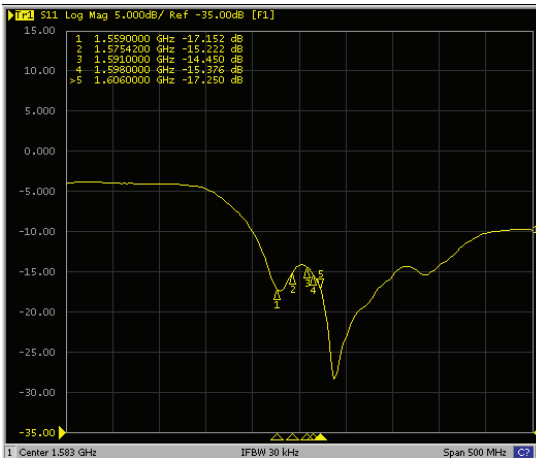

Figure 9 - Log Mag at 45deg

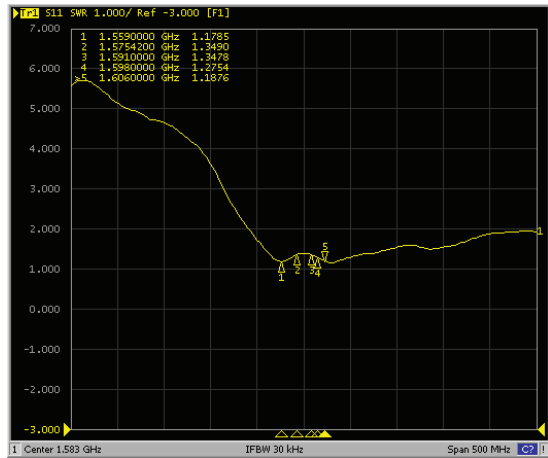

Figure 10 - VSWR at 45deg

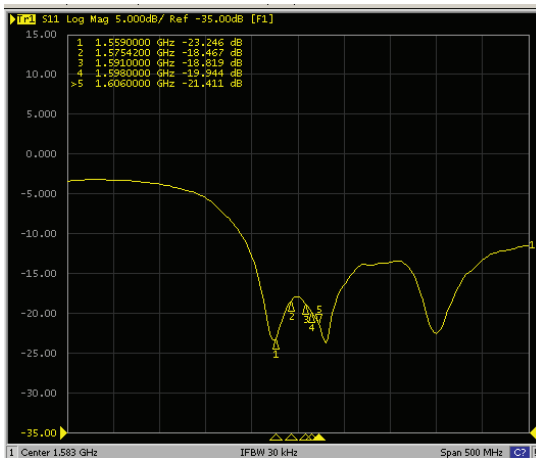

Figure 11 - Log Mag at 90deg

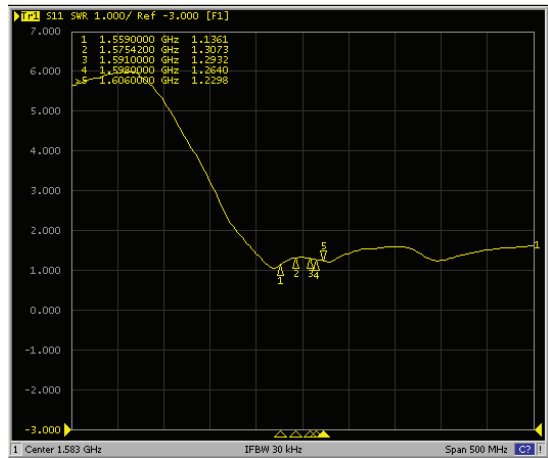

Figure 12 - VSWR at 90deg

ABRACON IS  
ISO9001:2008  
CERTIFIED



2 Faraday, Suite# B | Irvine | CA 92618 Revised: 06.11.15  
Ph. 949.546.8000 | Fax. 949.546.8001

Visit [www.abracon.com](http://www.abracon.com) for Terms and Conditions of Sale

# Multiband Antenna Module

**APAMPSLJ-140**

RoHS/RoHS II compliant



196.0 X 38.0 X 13.8mm

## EFFICIENCY

### LTE

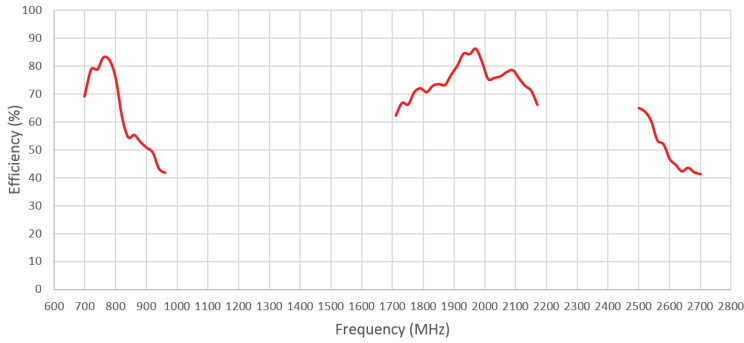

### GNSS

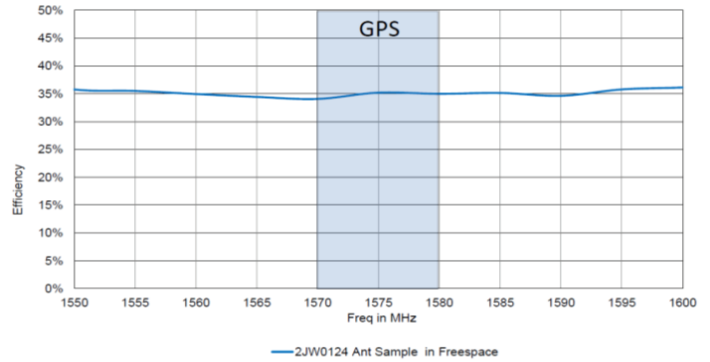

## OUTLINE DIMENSION:

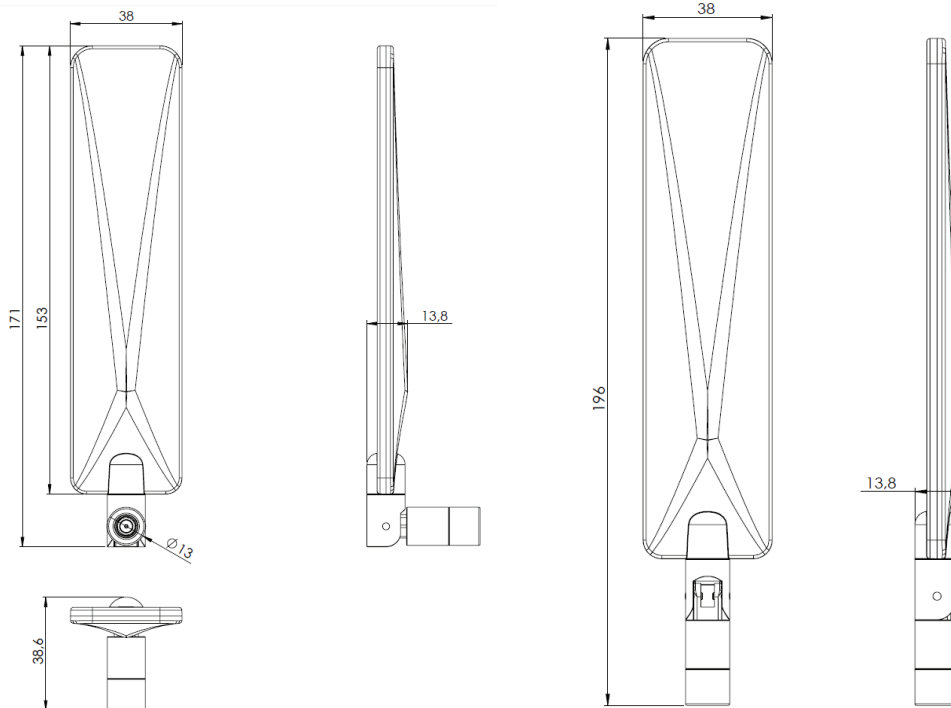

Parameters	Description
RF Connector	SMA Male
Weight	40 g
Material	ABS
Color	Black

ABRACON IS  
ISO9001:2008  
CERTIFIED



2 Faraday, Suite# B | Irvine | CA 92618 **Revised: 06.11.15**  
Ph. 949.546.8000 | Fax. 949.546.8001

Visit [www.abracon.com](http://www.abracon.com) for Terms and Conditions of Sale

# Multiband Antenna Module

APAMPSLJ-140

RoHS/RoHS II compliant



196.0 X 38.0 X 13.8mm

## PRODUCT IMAGE:



## PACKAGING:

Each antenna is individually packaged in a poly bag. 200pcs is the suggested quantity per 465 x 310 x 250mm box.



### CAUTION:

- (1) Do not apply excess mechanical stress to the component body or terminations. Do not attempt to re-form or bend the components as this will cause damage to the component.
- (2) Do not expose the component to open flame.
- (3) This specification applies to the functionality of the component as a single unit. Please insure the component is thoroughly evaluated in the application circuit.

**ATTENTION:** Abracon Corporation's products are COTS – Commercial-Off-The-Shelf products; suitable for Commercial, Industrial and, where designated, Automotive Applications. Abracon's products are not specifically designed for Military, Aviation, Aerospace, Life-dependant Medical applications or any application requiring high reliability where component failure could result in loss of life and/or property. For applications requiring high reliability and/or presenting an extreme operating environment, written consent and authorization from Abracon Corporation is required. Please contact Abracon Corporation for more information.

ABRACON IS  
ISO9001:2008  
CERTIFIED

 **ABRACON**<sup>®</sup> LLC  
The Power of Linking Together

2 Faraday, Suite# B | Irvine | CA 92618 **Revised: 06.11.15**  
Ph. 949.546.8000 | Fax. 949.546.8001  
Visit [www.abracon.com](http://www.abracon.com) for Terms and Conditions of Sale