



SANYO Semiconductors

DATA SHEET

An ON Semiconductor Company

LV5072M — Bi-CMOS IC DC/DC Converter IC

Overview

The SANYO LV5072M is a DC/DC converter IC that has a step-down DC/DC converter output and an externally-controllable GPO output for discharging the output capacitor.

Features

- One channel of synchronous rectifying PWM controlled step-down DC/DC converter output (0.8V to 3.3V/2A)
- One channel of externally controllable GPO output for discharging the output capacitor
- Built-in thermal shutdown circuit
- Built-in hiccup recovery

Specifications

Maximum Ratings at Ta = 25°C

Parameter	Symbol	Conditions	Ratings	Unit
Maximum supply voltage	V _{IN}	V _{IN} , P _{VIN}	-0.3 to 6.0	V
Input pin voltage	V _{INC}	GPI, ENDCO	-0.3 to 6.0	V
Output pin voltage	V _{OUT}	LX, GPO	-0.3 to 6.0	V
Allowable Power dissipation	P _{d max}	Ta = 25°C Mounted on a circuit board.*	1.5	W
Operating temperature	T _{opr}		-20 to +85	°C
Storage temperature	T _{stg}		-40 to +125	°C

* Specified circuit board : 50.0mm × 50.0mm × 1.6mm, 2-layer glass epoxy printed circuit board, Wiring density on the backside = 54%

■ Any and all SANYO Semiconductor Co.,Ltd. products described or contained herein are, with regard to "standard application", intended for the use as general electronics equipment (home appliances, AV equipment, communication device, office equipment, industrial equipment etc.). The products mentioned herein shall not be intended for use for any "special application" (medical equipment whose purpose is to sustain life, aerospace instrument, nuclear control device, burning appliances, transportation machine, traffic signal system, safety equipment etc.) that shall require extremely high level of reliability and can directly threaten human lives in case of failure or malfunction of the product or may cause harm to human bodies, nor shall they grant any guarantee thereof. If you should intend to use our products for applications outside the standard applications of our customer who is considering such use and/or outside the scope of our intended standard applications, please consult with us prior to the intended use. If there is no consultation or inquiry before the intended use, our customer shall be solely responsible for the use.

■ Specifications of any and all SANYO Semiconductor Co.,Ltd. products described or contained herein stipulate the performance, characteristics, and functions of the described products in the independent state, and are not guarantees of the performance, characteristics, and functions of the described products as mounted in the customer's products or equipment. To verify symptoms and states that cannot be evaluated in an independent device, the customer should always evaluate and test devices mounted in the customer's products or equipment.

SANYO Semiconductor Co., Ltd.

www.semiconductor-sanyo.com/network

LV5072M

Operating Conditions at $T_a = 25^\circ\text{C}$

Parameter	Symbol	Conditions	Ratings	Unit
Supply voltage	V_{IN}	$V_{IN} = PV_{IN}, 0.8V \leq V_{OUT} \leq 1.3V$	2.95 to 5.5	V
		$V_{IN} = PV_{IN}, 1.3V \leq V_{OUT} \leq 1.9V$	3.2 to 5.5	V
		$V_{IN} = PV_{IN}, 1.9V \leq V_{OUT} \leq 3.3V$	4.5 to 5.5	V
Input pin voltage	V_{INC}	GPI, ENDCO	-0.3 to V_{IN}	V

Electrical Characteristics, Current drain, unless otherwise specified at $T_a = 25^\circ\text{C}$, $V_{IN} = 5.0V$, no load

Parameter	Symbol	Conditions	Ratings			Unit
			min	typ	max	
Standby current drain	I_{CCSB}	GPI = ENDCO = Low		0.5	10	μA
Current drain DCDC ON	I_{CCFL}	GPI = ENDCO = High, $V_{OUT} = 1.8V$		12	16	mA

DC/DC, unless otherwise specified at $T_a = 25^\circ\text{C}$, $V_{IN} = 5.0V$, $V_{OUT} = 1.8V$, no load

Parameter	Symbol	Conditions	Ratings			Unit
			min	typ	max	
FB voltage	VFB	$I_O = 10\text{mA}$	0.49	0.50	0.51	V
Current limit peak value	CLIMIT		2.3			A
Efficiency 1	EF1	$I_O = 0.5A, V_{OUT} = 3.3V$		90		%
Efficiency 2	EF2	$I_O = 0.5A, V_{OUT} = 1.8V$		82		%
Load regulation	VL	$I_O = 1\text{mA}$ to 2A		25	70	mV
Frequency	Fosc		1.7	2.2	2.7	MHz
LX ON resistance	RLXP	$I_{OH} = -300\text{mA}$, Pch		0.15		Ω
	RLXN	$I_{OL} = 300\text{mA}$, Nch		0.15		Ω

GPI, ENDCO Input, GPO Output, unless otherwise specified at $T_a = 25^\circ\text{C}$, $V_{IN} = 5.0V$

Parameter	Symbol	Conditions	Ratings			Unit
			min	typ	max	
GPO Output current	I_{gpo}	GPI = 0V, GPO = 1.5V	7.5	15	37.5	mA
GPO output voltage Low-level	V_{OL}	GPI = 0V, $I_{OL} = 5\text{mA}$		0.5	1	V
GPO output leakage current	ILK	GPO		0	10	μA
GPI/ENDCO input voltage High-level	V_{INH}	Input High-level GPI, ENDCO	1.5			V
GPI/ENDCO input voltage Low-level	V_{INL}	Input Low-level GPI, ENDCO	0		0.3	V

Package Dimensions

unit : mm (typ)

3384

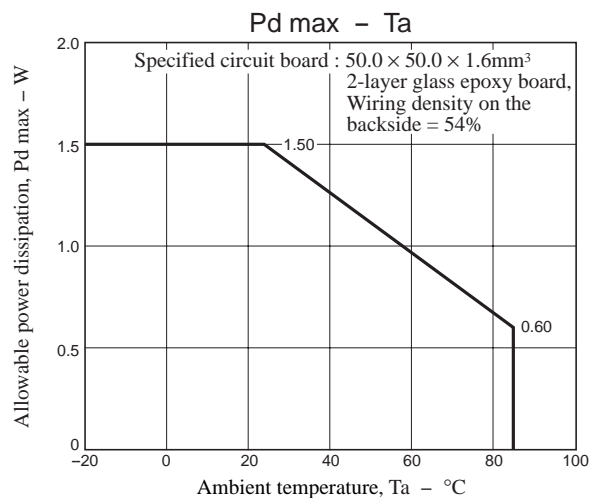
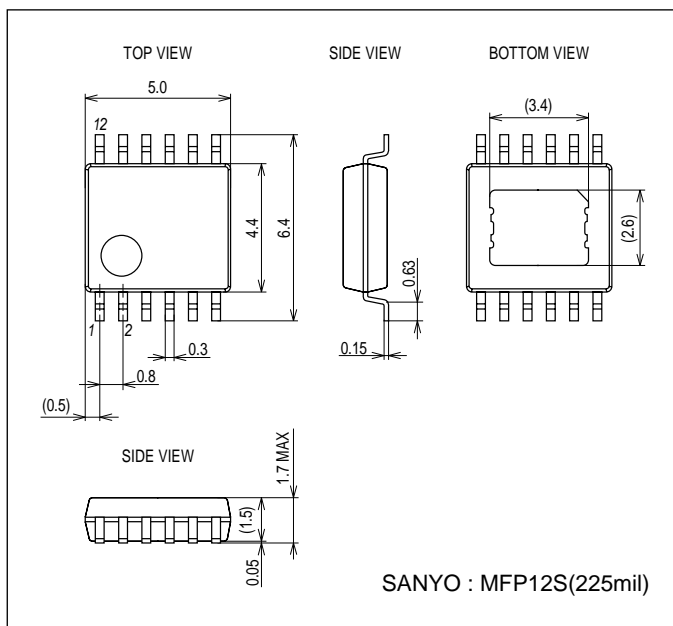

LV5072M

Specified board for Pd max measurement

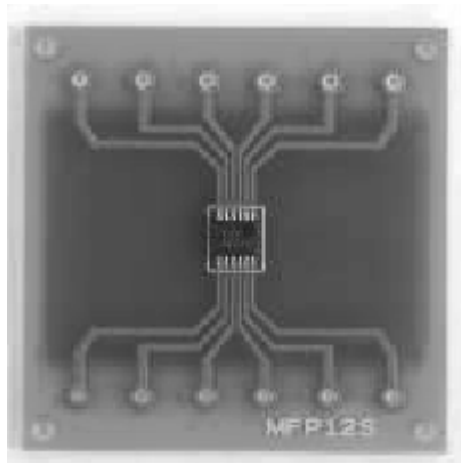

Pin Assignment

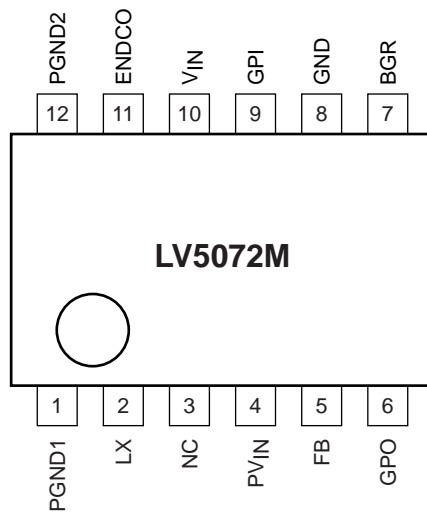

Top view

Block Diagram

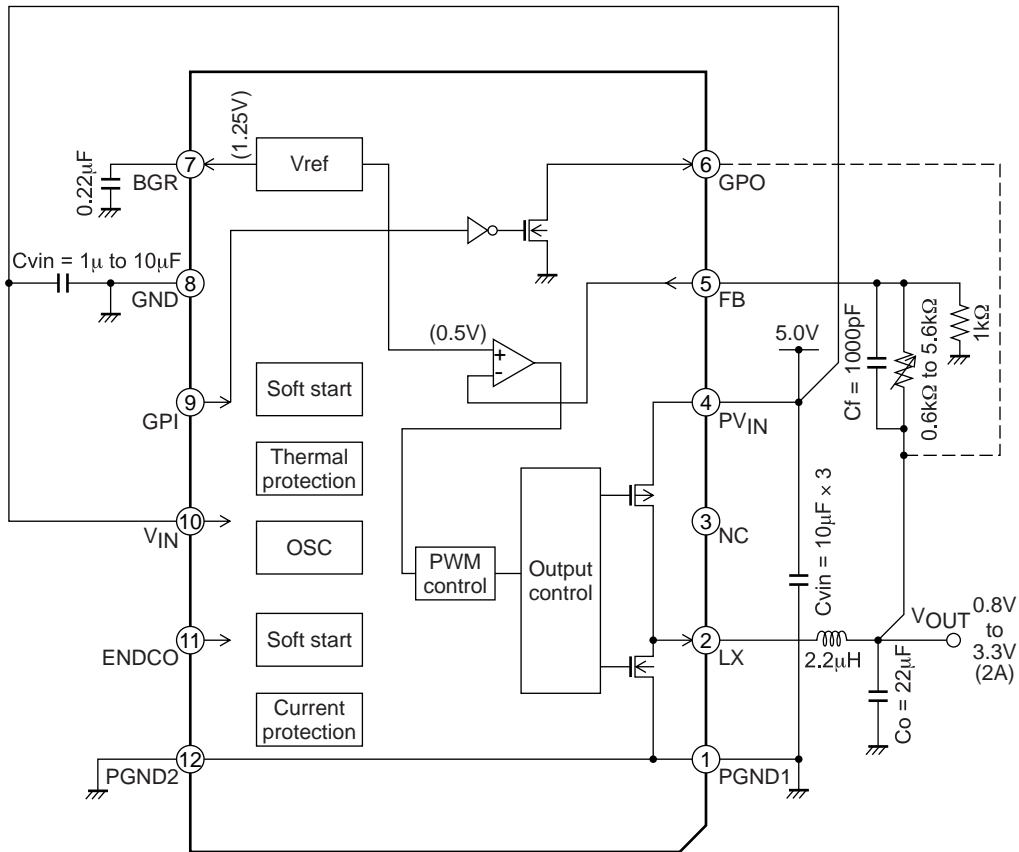

Pin Descriptions

Pin No.	Pin name	Description
1	PGND1	DC/DC power-dedicated ground
2	LX	Switching regulator PWM output pin
3	NC	NC
4	PVIN	DC/DC power dedicated power pin
5	FB	DC/DC feedback voltage input pin
6	GPO	GPO output for discharging the output capacitor
7	BGR	Internal reference voltage output pin
8	GND	Signal ground
9	GPI	GPO output control pin. L : Output capacitor discharge
10	VIN	Signal system power supply
11	ENDCO	DC/DC output control pin. Low : OFF, High : ON
12	PGND2	DC/DC power dedicated ground

LV5072M

Pin Functions

Pin No.	Pin Name	Pin function	Equivalent Circuit
2	LX	Switching regulator PWM signal output	
5	FB	Switching regulator Feedback voltage input	
6	GPO	GPO output for discharging the output capacitor	
7	BGR	Reference voltage output	

Continued on next page.

LV5072M

Continued from preceding page.

Pin No.	Pin Name	Pin function	Equivalent Circuit
9	GPI	GP0 output control pin (Low : Discharging the output capacitor)	
11	ENDCO	DC/DC on/off control (High : Converter ON)	

LV5072M

Evaluation Board

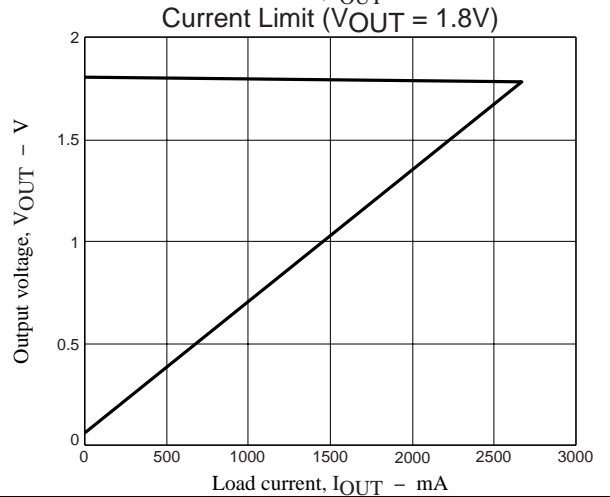
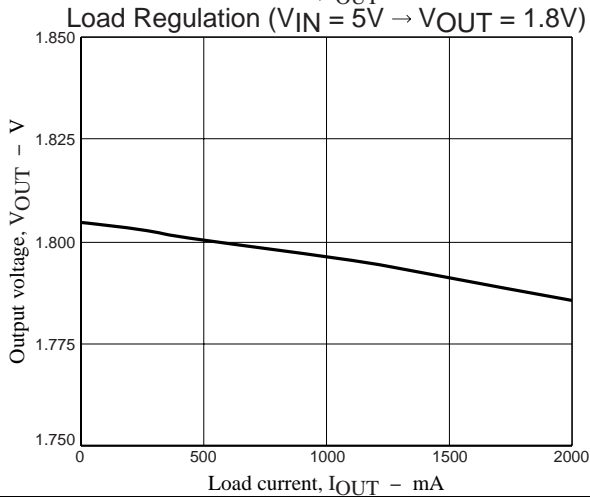
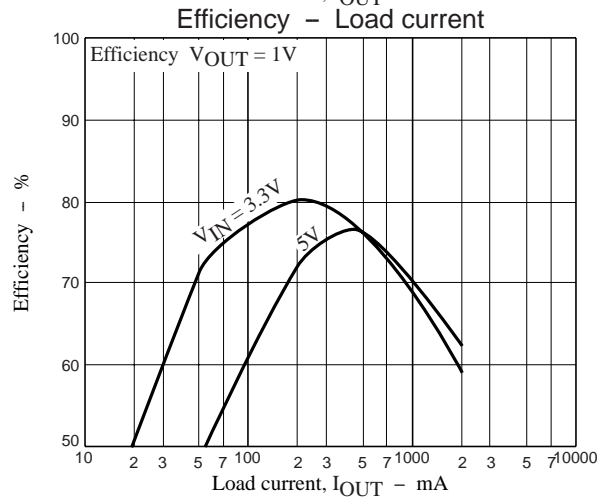
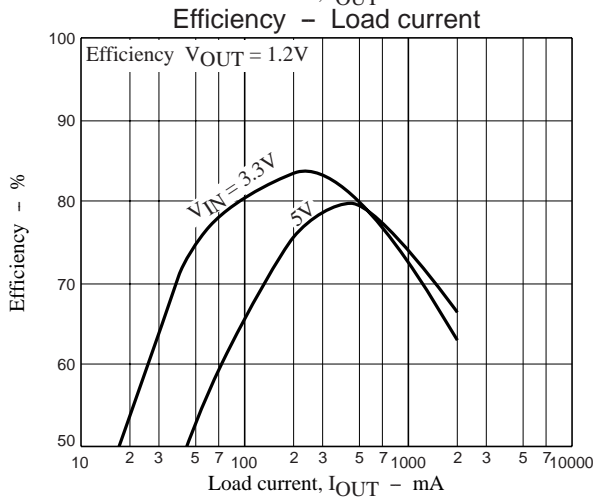
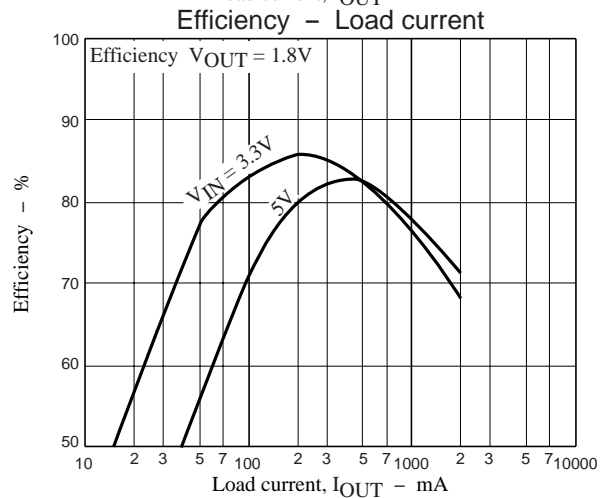
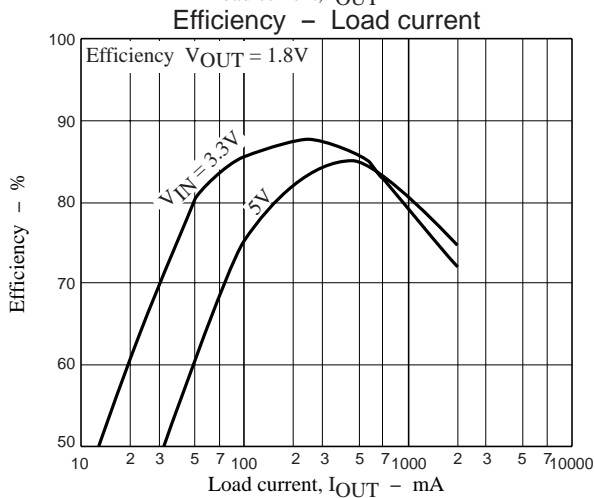
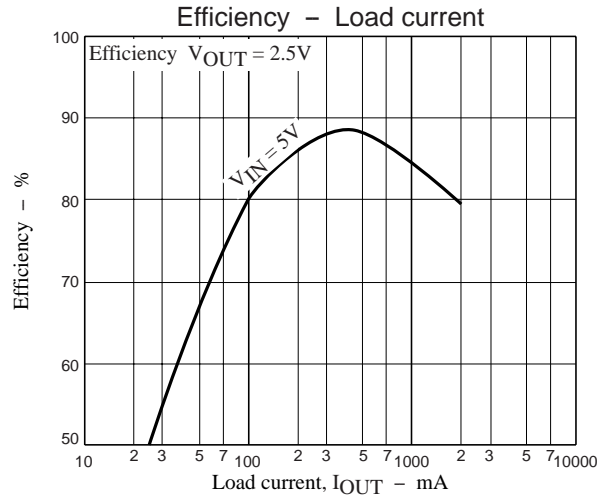
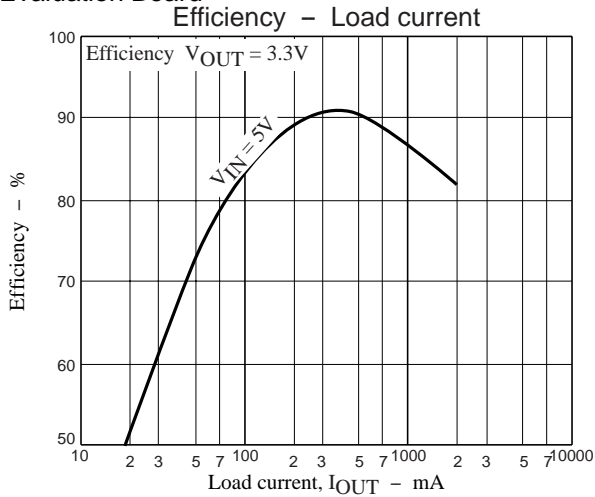

LV5072M

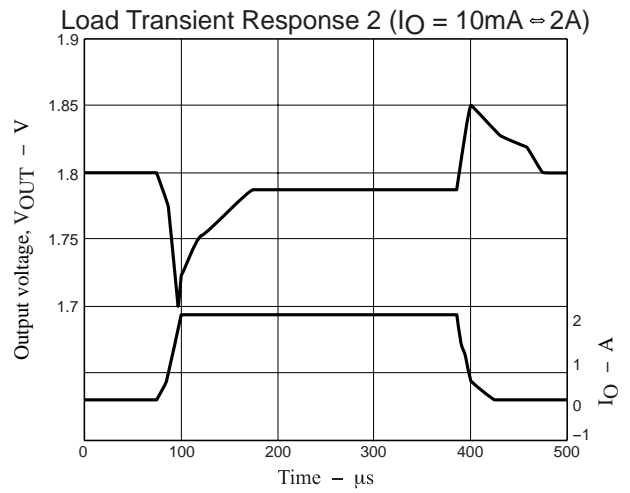
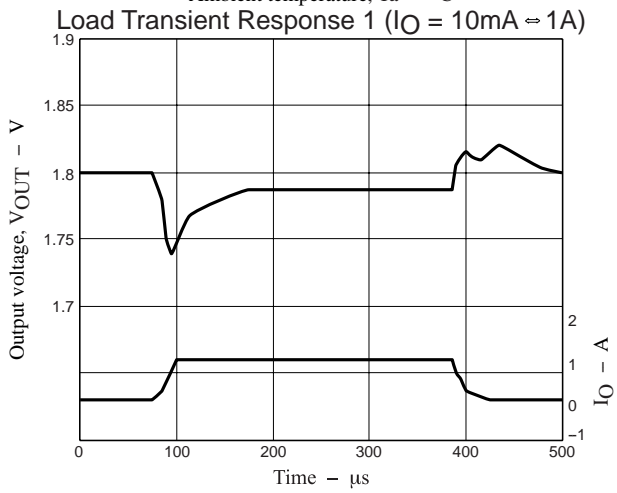
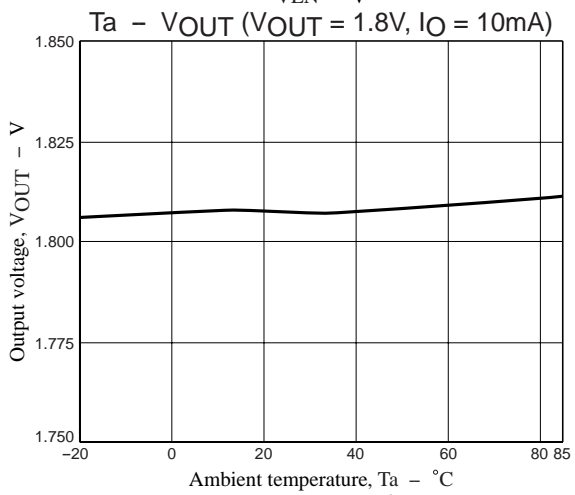
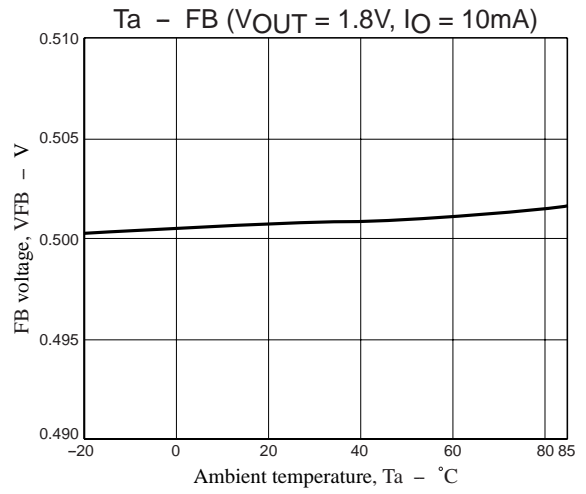
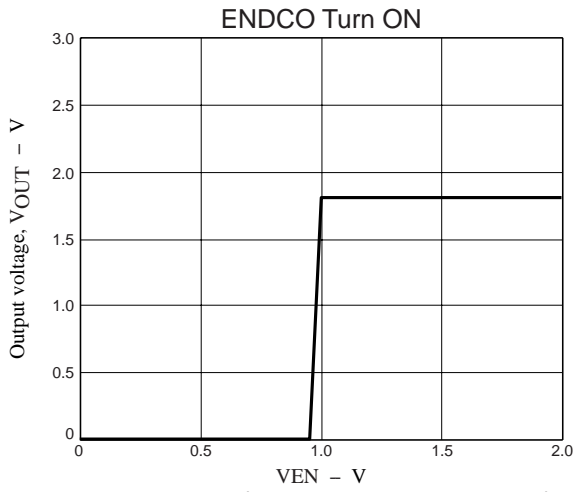

LV5072M

ENDCO ON Waveforms. ($V_{OUT} = 1.8V$, $C_o = 22\mu F$, $C_{vin} = 1\mu F$, $C_{pvin} = 10\mu F \times 3$, $CBGR = 0.22\mu F$)

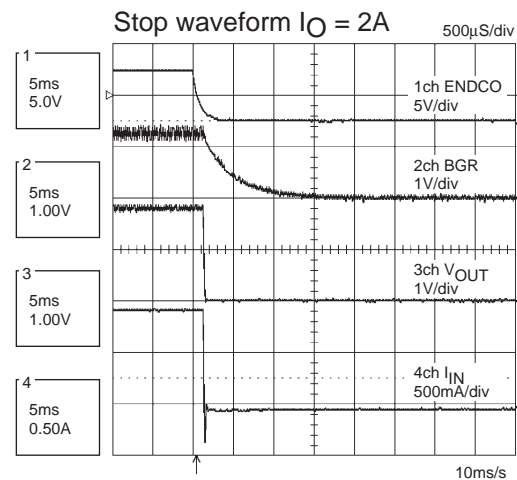
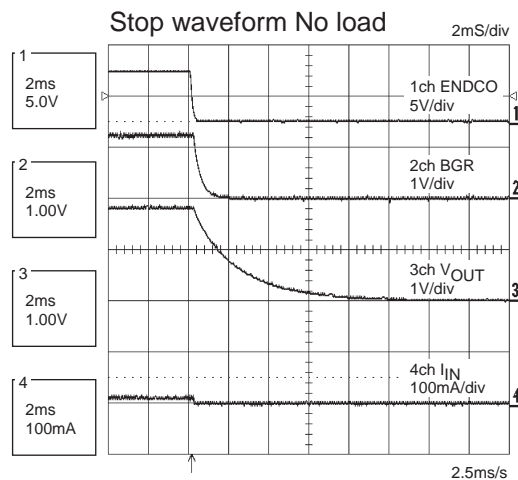
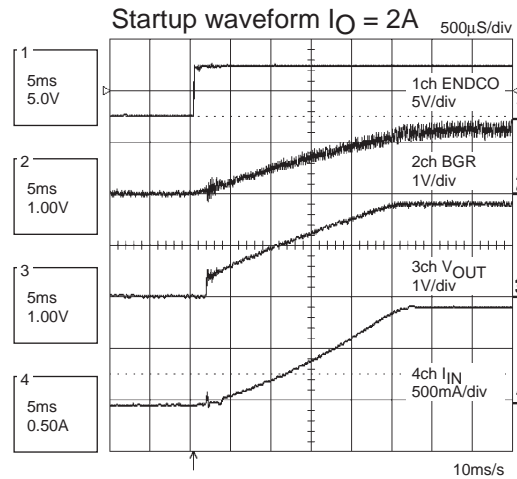
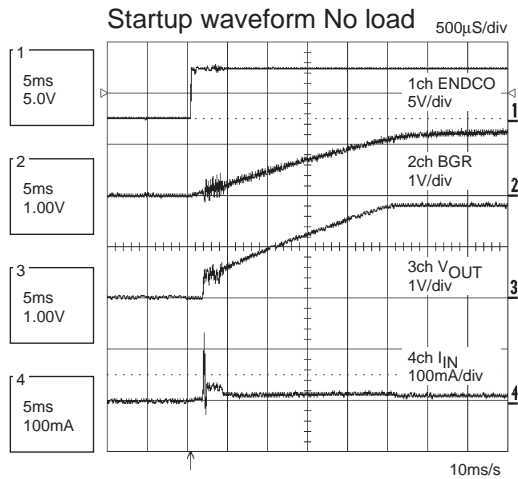

- SANYO Semiconductor Co.,Ltd. assumes no responsibility for equipment failures that result from using products at values that exceed, even momentarily, rated values (such as maximum ratings, operating condition ranges, or other parameters) listed in products specifications of any and all SANYO Semiconductor Co.,Ltd. products described or contained herein.
- SANYO Semiconductor Co.,Ltd. strives to supply high-quality high-reliability products, however, any and all semiconductor products fail or malfunction with some probability. It is possible that these probabilistic failures or malfunction could give rise to accidents or events that could endanger human lives, trouble that could give rise to smoke or fire, or accidents that could cause damage to other property. When designing equipment, adopt safety measures so that these kinds of accidents or events cannot occur. Such measures include but are not limited to protective circuits and error prevention circuits for safe design, redundant design, and structural design.
- In the event that any or all SANYO Semiconductor Co.,Ltd. products described or contained herein are controlled under any of applicable local export control laws and regulations, such products may require the export license from the authorities concerned in accordance with the above law.
- No part of this publication may be reproduced or transmitted in any form or by any means, electronic or mechanical, including photocopying and recording, or any information storage or retrieval system, or otherwise, without the prior written consent of SANYO Semiconductor Co.,Ltd.
- Any and all information described or contained herein are subject to change without notice due to product/technology improvement, etc. When designing equipment, refer to the "Delivery Specification" for the SANYO Semiconductor Co.,Ltd. product that you intend to use.
- Information (including circuit diagrams and circuit parameters) herein is for example only; it is not guaranteed for volume production.
- Upon using the technical information or products described herein, neither warranty nor license shall be granted with regard to intellectual property rights or any other rights of SANYO Semiconductor Co.,Ltd. or any third party. SANYO Semiconductor Co.,Ltd. shall not be liable for any claim or suits with regard to a third party's intellectual property rights which has resulted from the use of the technical information and products mentioned above.

This catalog provides information as of March, 2010. Specifications and information herein are subject to change without notice.