

## DETAILS

<b>Product Number</b>	FP13028_LISA2-M-PIN
<b>Family</b>	Lisa
<b>Type</b>	Assembly
<b>Color</b>	black
<b>Diameter</b>	9,9 mm
<b>Height</b>	6,8 mm
<b>Style</b>	round
<b>Optic Material</b>	PMMA
<b>Holder Material</b>	
<b>Fastening</b>	pin, glue
<b>Status</b>	production ready
<b>ROHS Compliant</b>	Yes
<b>Date Updated</b>	15/04/2016



## OPTICAL PROPERTIES

LED	Viewing Angle	Light Beam	Efficiency	cd/lm	Connector
XT-E	26 deg	Medium	89 %	3.260	-
XP-G2	25 deg	Medium	89 %	3.500	-
XP-G3	21 deg	Medium	84 %	3.600	-
LUXEON T	28 deg	Medium	87 %	2.700	-
LUXEON TX	26 deg	Medium	88 %	3.380	-
NCSxx19B	23 deg	Medium	85 %	4.100	-
NVSxx19B/NVSxx19C	30 deg	Medium	86 %	2.400	-
SFH 4715S	22 deg	Medium	-	-	-
SFH 4725S	23 deg	Medium	-	-	-
Oslon Square EC	26 deg	Medium	84 %	3.400	-
SFH 4715AS	sim: 26	Medium	sim: 89 %	-	-
LH351Z	26 deg	Medium	87 %	3.500	-
LH351B	31 deg	Medium	87 %	2.600	-
Z8Y22P	sim: 25	Medium	sim: 84 %	sim: 2.660	-

Relative intensity of FP13028\_LISA2-M-PIN-(sfh4715s)

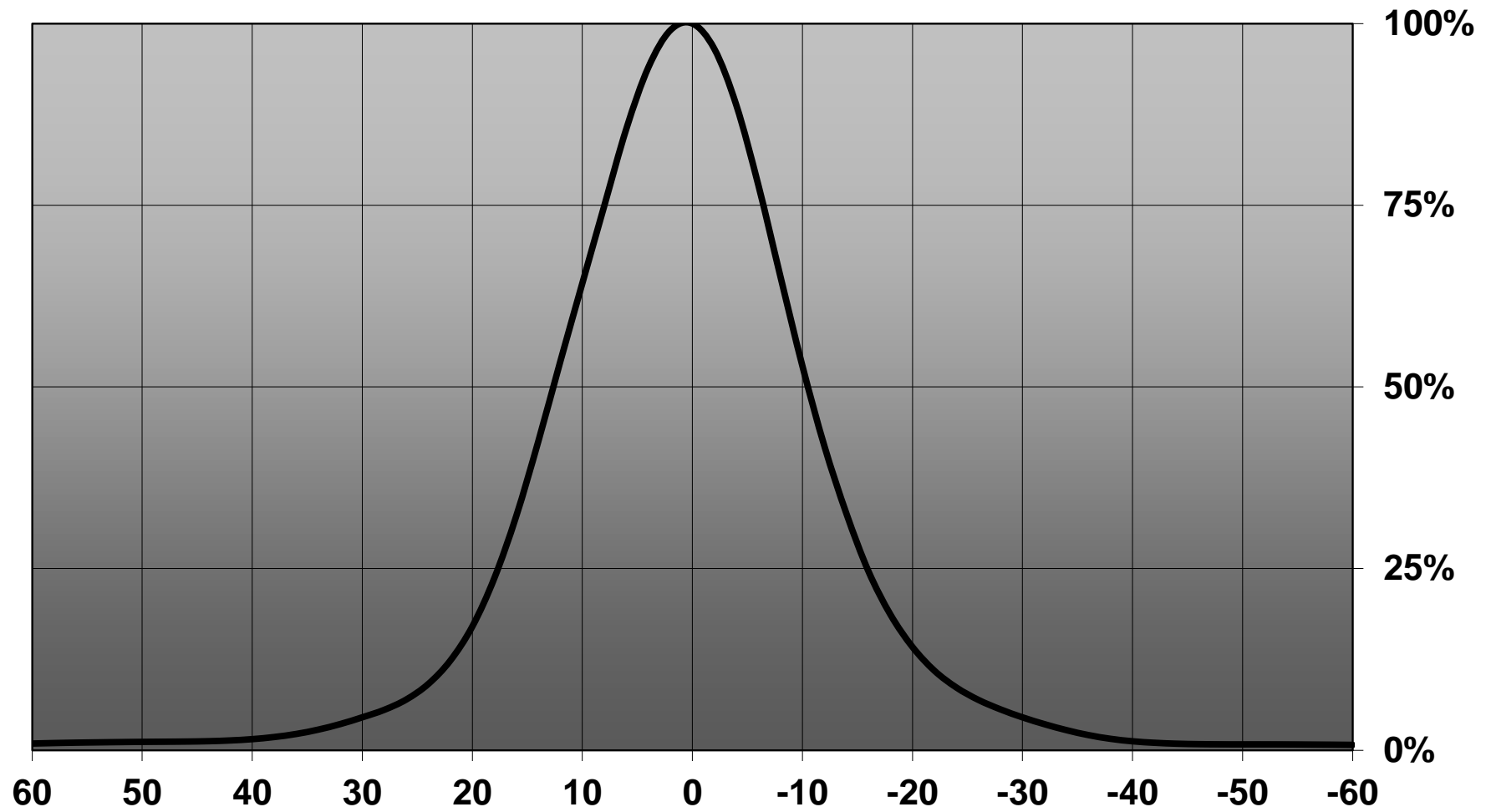

### Relative intensity of FP13028\_LISA2-M-PIN\_(SFH4725S)

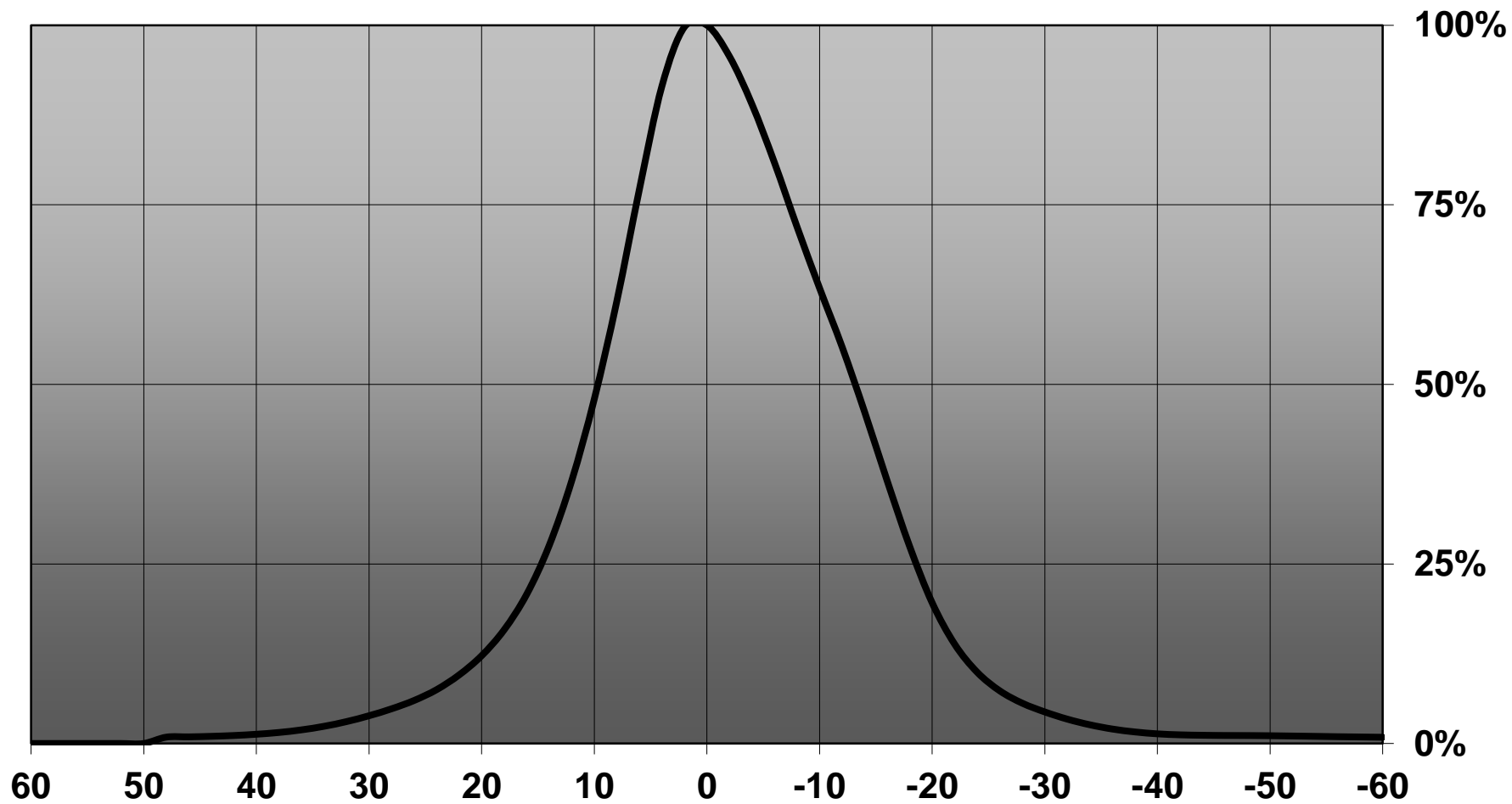

Relative intensity of FP13028\_LISA2-M\_(PINLH351B)

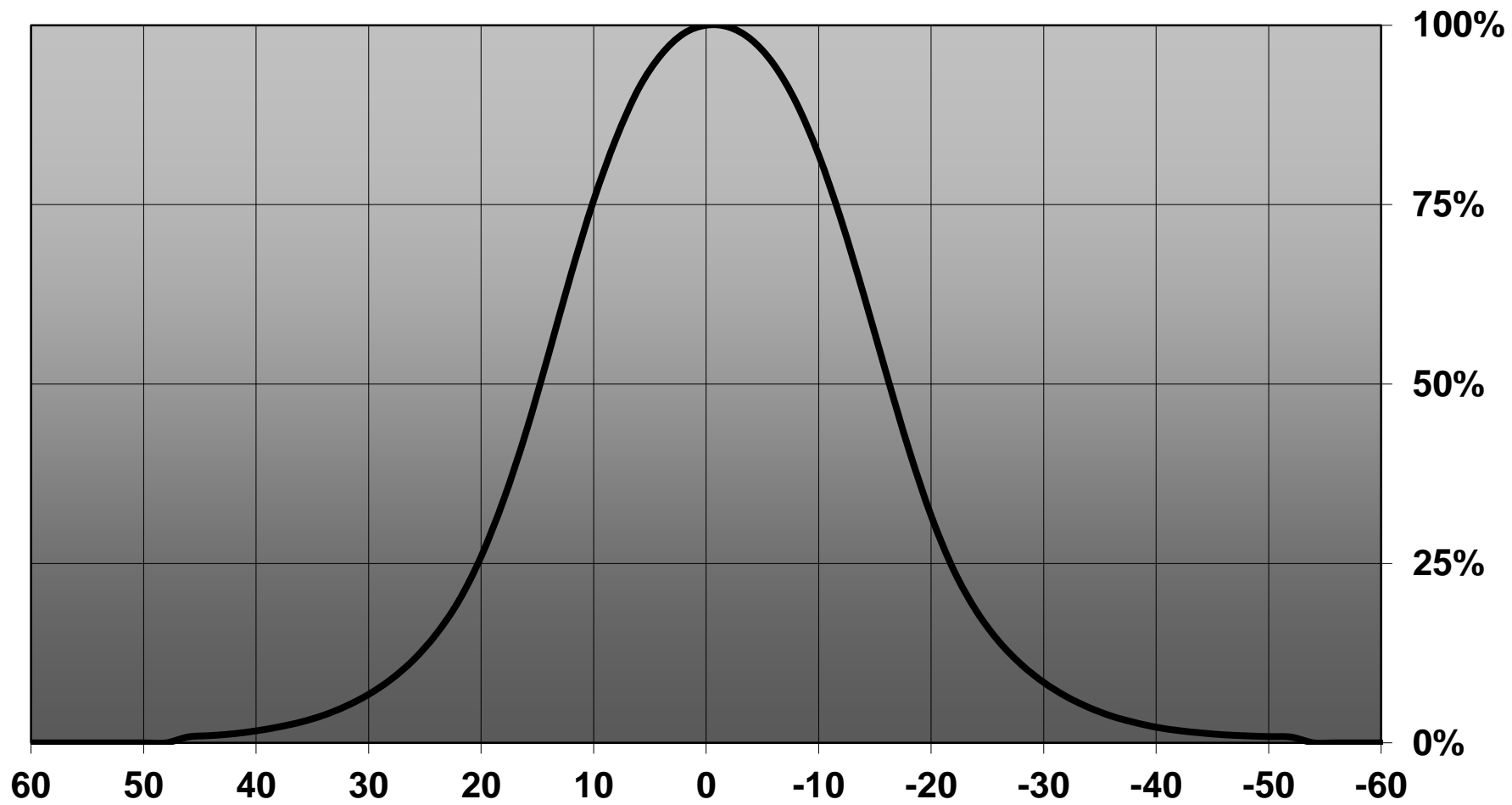

D

C

B

A

4

4

3

3

2

2

1

1

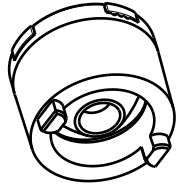
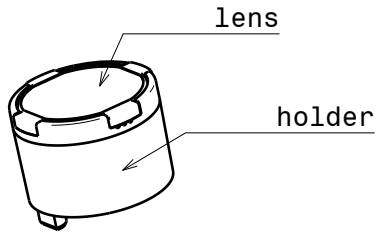

Isometric view  
Scale: 2:1

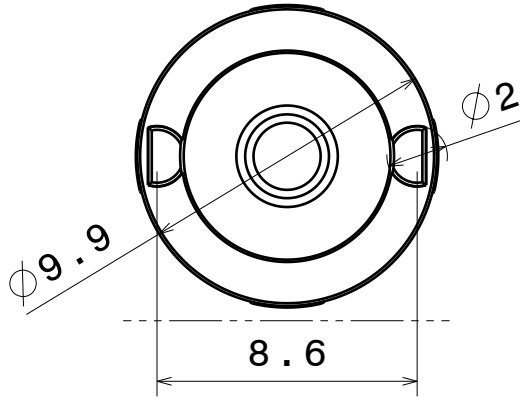

Bottom view

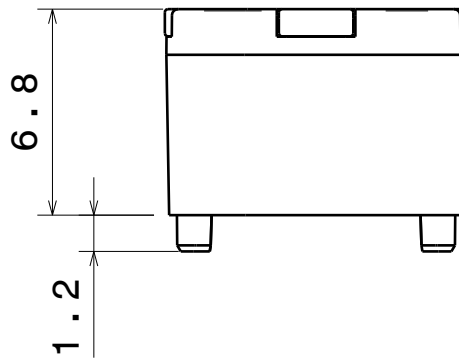

Front view

Materials:  
Lens PMMA  
Holder PC

This drawing is our property.  
It can't be reproduced  
or communicated without  
our written agreement.



Ledil Oy  
Salorankatu 10  
FIN-24240 SALO  
Finland

DRAWING TITLE

Datasheet Lisa2-Pin-XT Series Assy

DRAWN BY pl	DATE 20.06.2012	DRAWING TITLE Datasheet Lisa2-Pin-XT Series Assy		
CHECKED BY	DATE	SIZE A4	DRAWING NUMBER	REV 1
DESIGNED BY pl	DATE 20.06.2012	SCALE 4:1	WEIGHT (g)	SHEET 1/1

D

A

Luminaire: LEDiL Oy FP13030&FP13028\_LISA2-M\_PIN&CLIP Ef. 89%  
Lamps: 1 x Cree XT-E 104lm@250mA CCT=5000K P=0.77W I=250mA

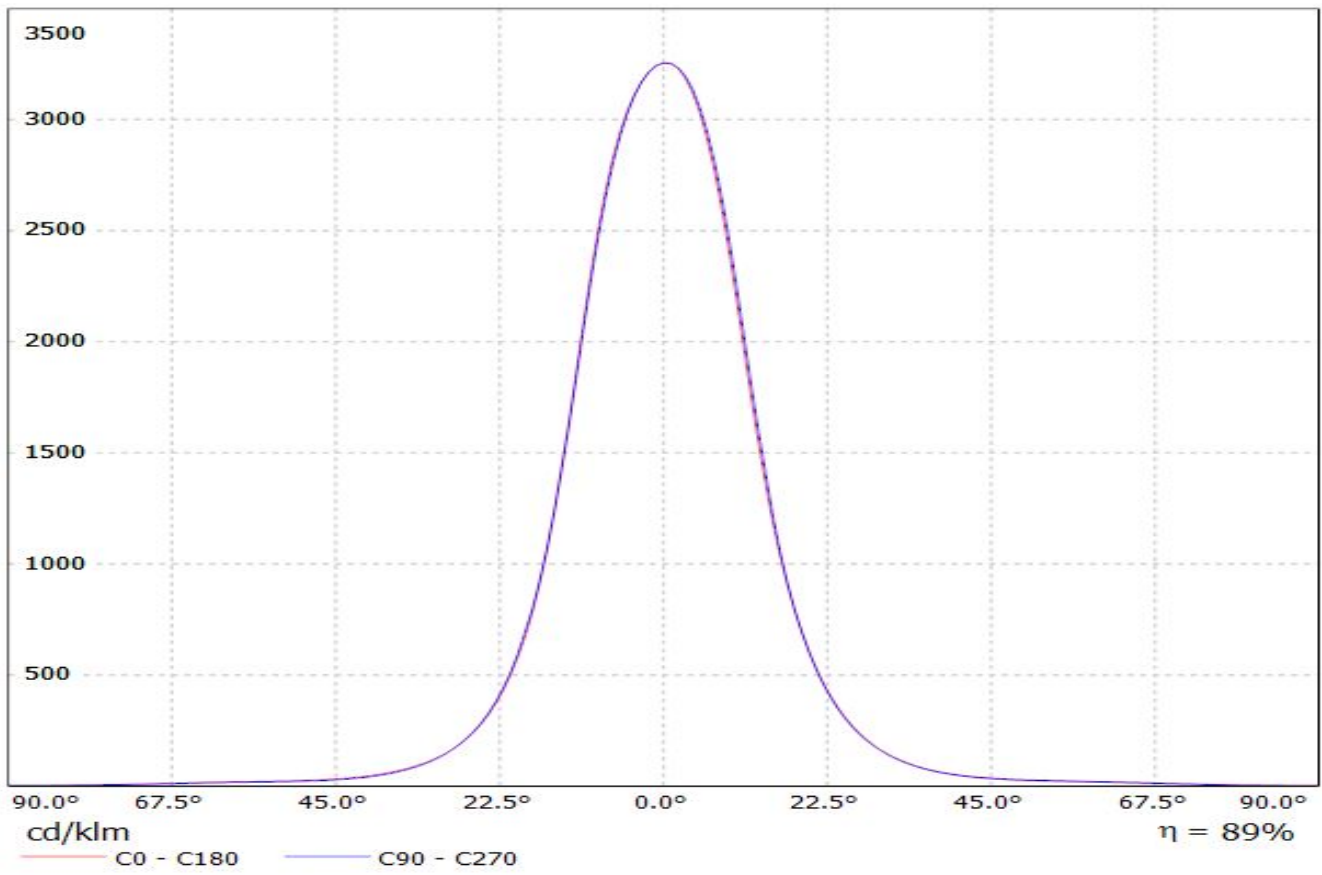

Luminaire: LEDiL Oy FP13028&FP13030\_LISA2-M\_(XP-G2) Eff. 89%  
Lamps: 1 x Cree\_(XP-G2) 104lm@250mA CCT=6600K P=0.76W I=250mA

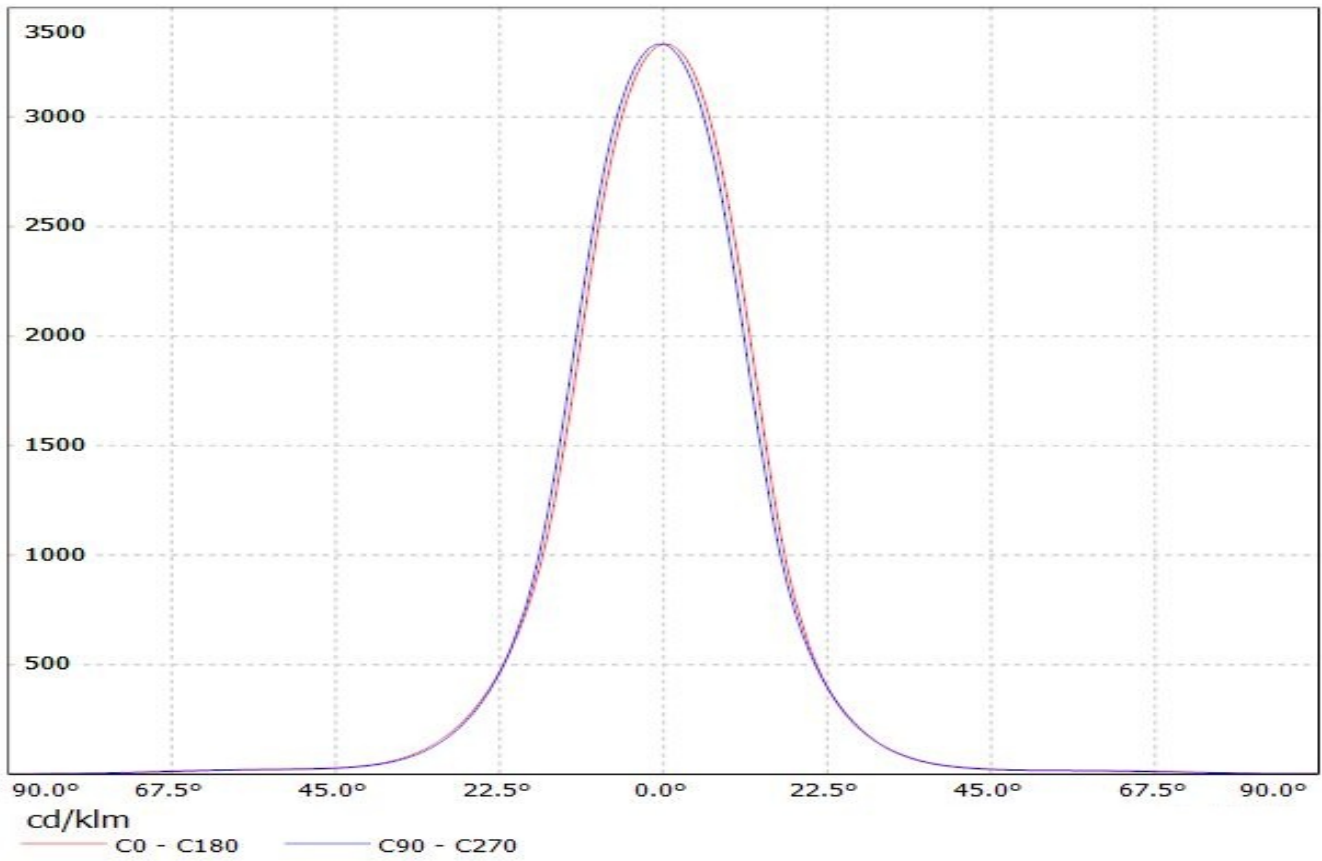

Luminaire: Ledil Oy  
Lamps: 1 x

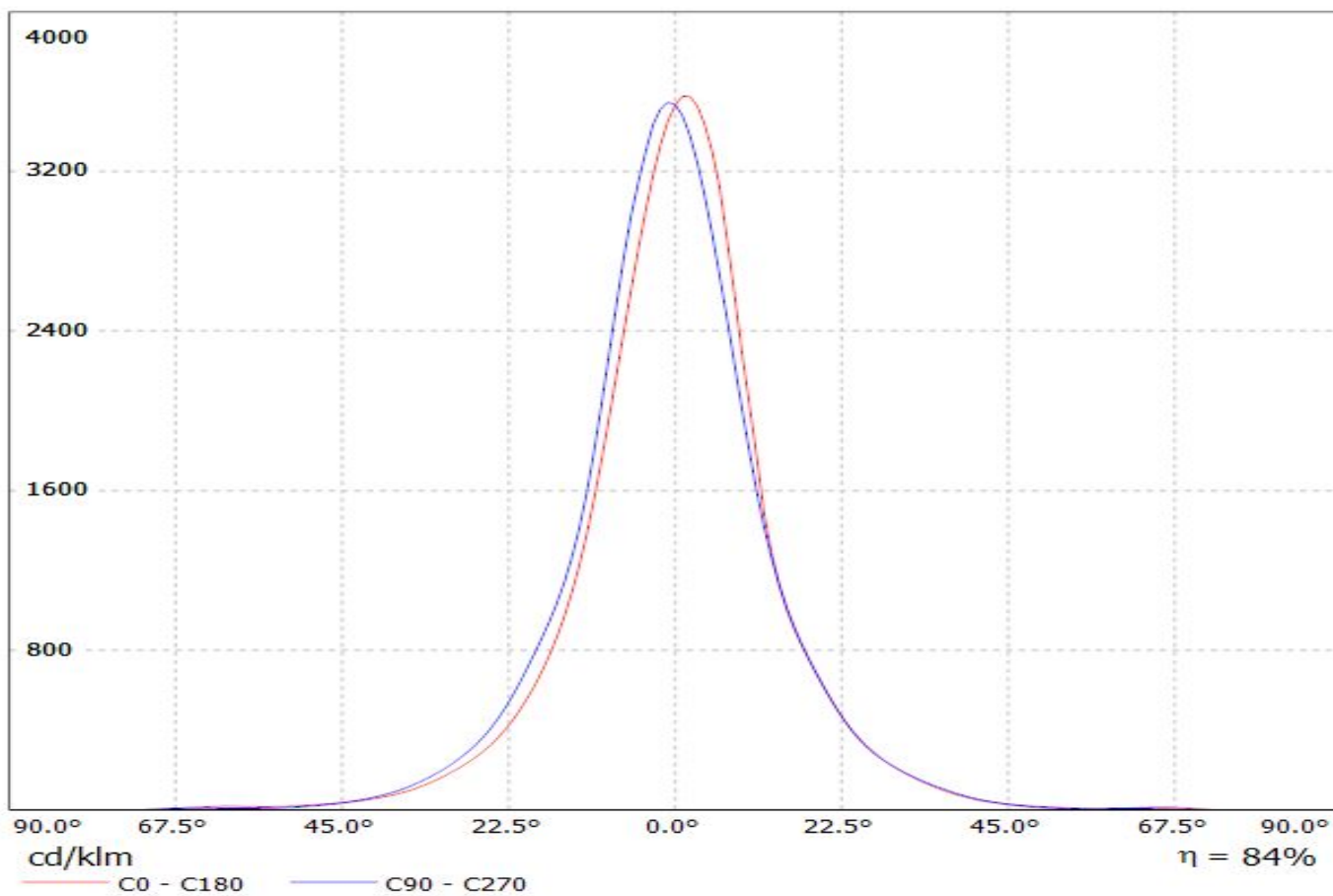



Luminaire: LEDiL Oy FP13030&FP13028\_LISA2-M\_(CLIP&PIN) Eff.86.6%  
Lamps: 1 x LUXEON\_T (74lm@250mA)

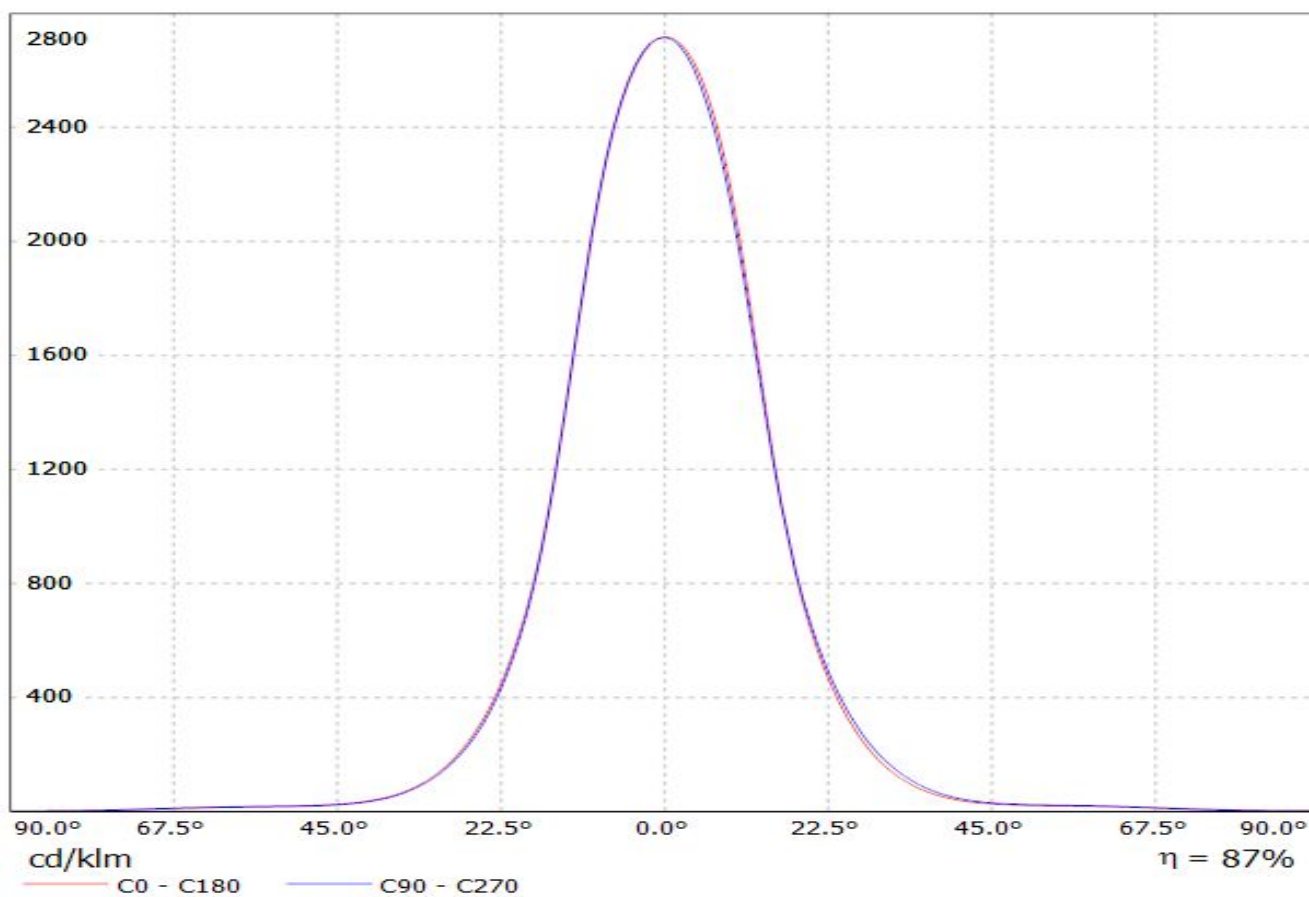

Luminaire: Ledil Oy FP13028\_LISA2-M-PIN\_(Luxeon\_TX) Efficiency=88%  
Lamps: 1 x Luxeon TX (L1T2-3585) 108lm @ 250mA CCT=3521K P=0.73W I=250mA

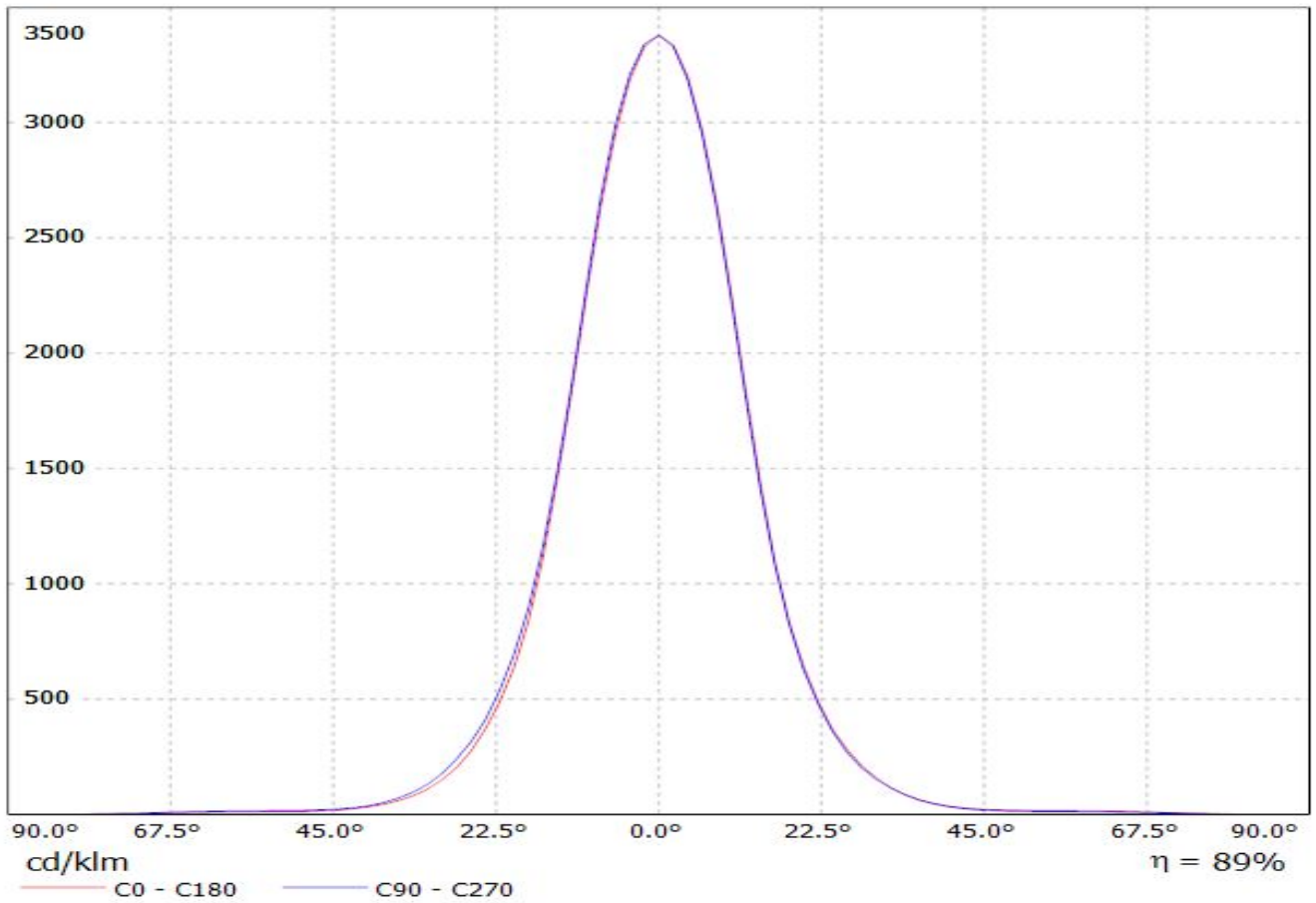

Luminaire: Ledil Oy FP13028\_LISA2-M-PIN (NCSxx19B) Efficiency=85%  
Lamps: 1 x Nichia NCSxx19B (NCSL119BE) 88lm @ 250mA CCT=3000K P=0.8W I=250mA

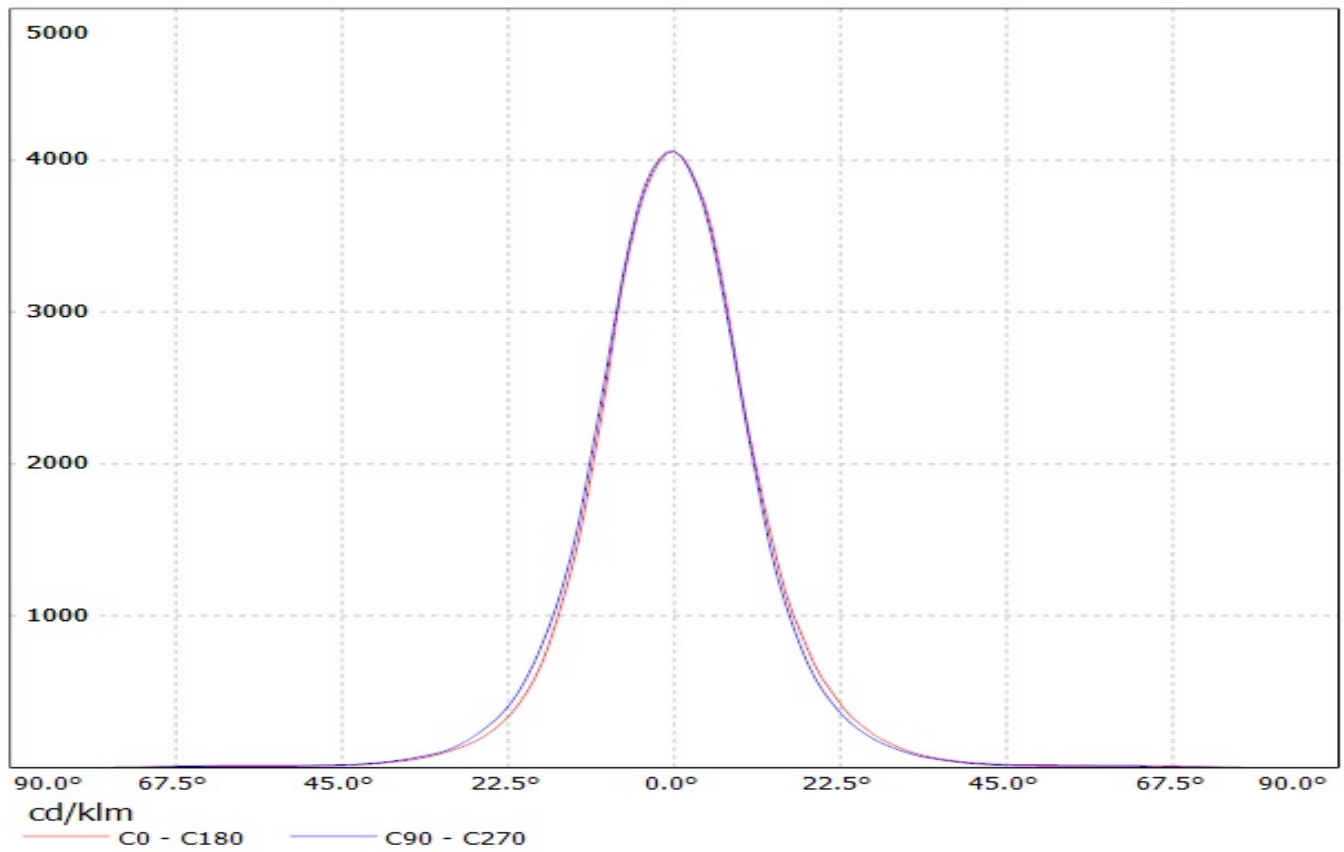

Luminaire: LEDiL Oy FP13028\_LISA2-M-PIN\_(NVSL219CE)  
Lamps: 1 x Nichia\_NVSL219CE\_101.052lm@250mA\_P=0.713154W\_I=0.25A

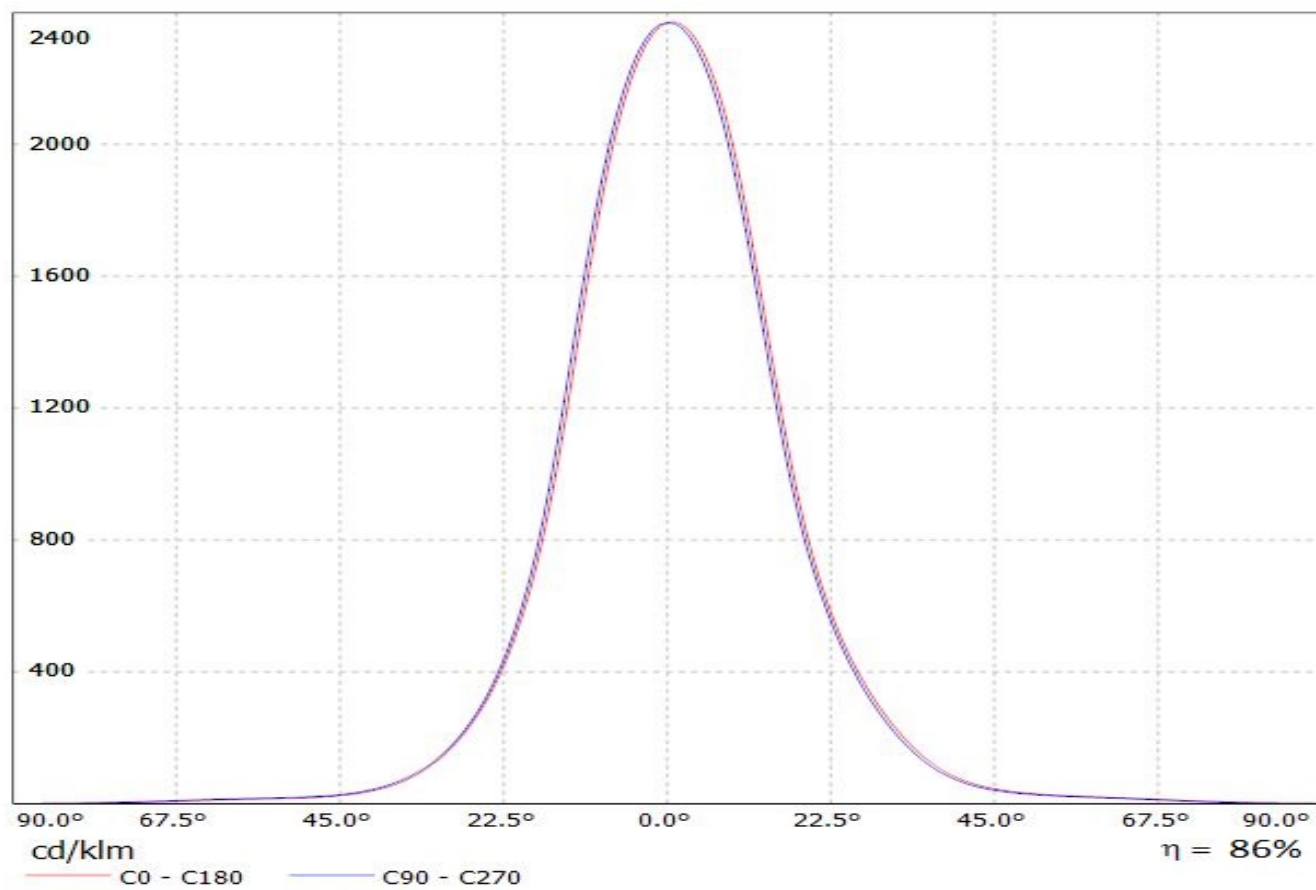

Luminaire: LEDiL Oy  
Lamps: 1 x FP13028\_LISA2-M-PIN\_(SQ)

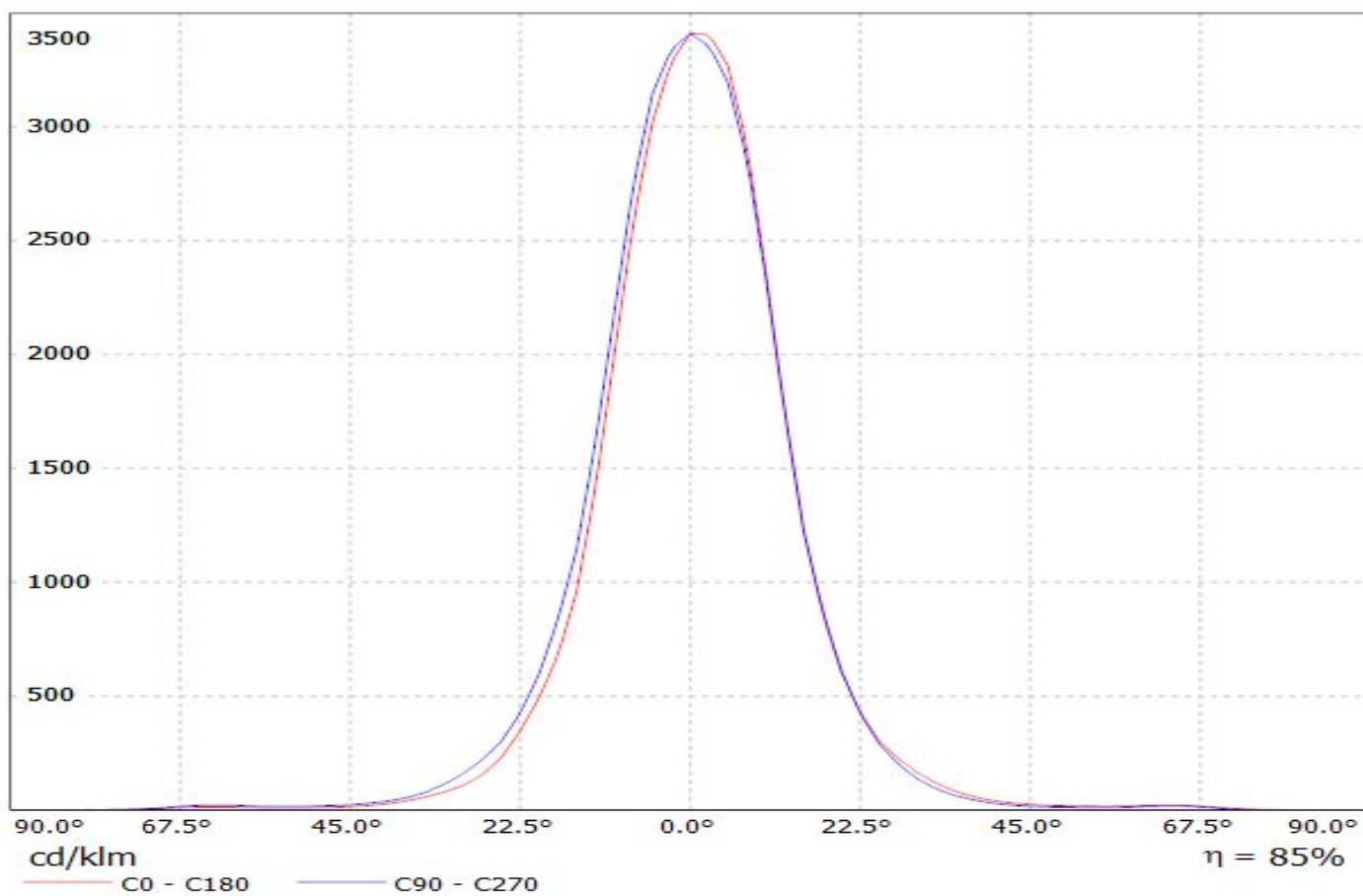

Luminaire: Ledil Oy FP13028\_LISA2-M-PIN\_(SFH\_4715AS)\_SIMULATED  
Lamps: 1 x Osram SFH 4715AS

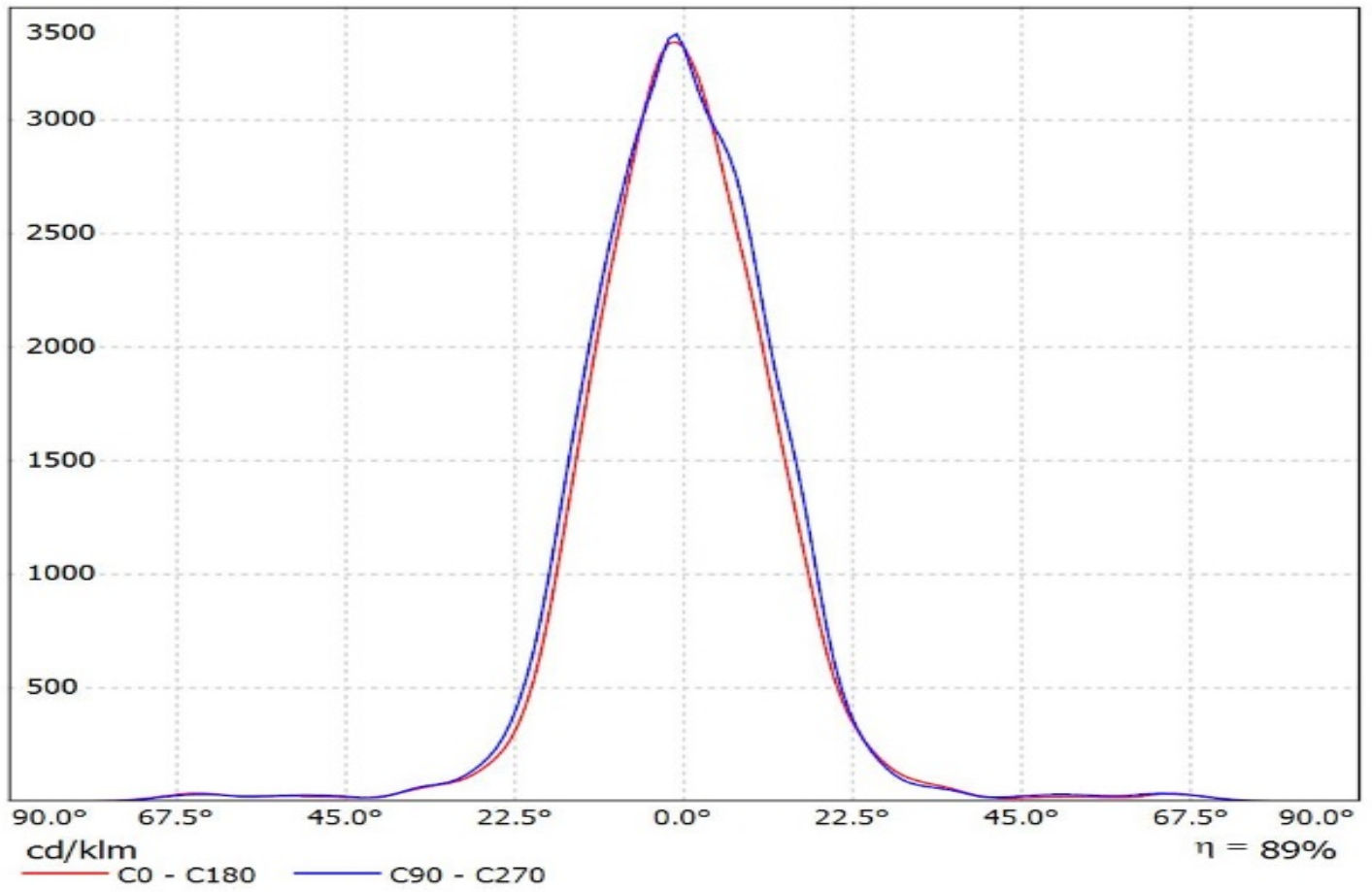

Luminaire: Ledil Oy FP13028\_LISA2-M-PIN\_(LH351Z) Efficiency=87%  
Lamps: 1 x Samsung LH351Z (90.14lm @ 250mA) CCT=6500K P=0.7W I=250mA

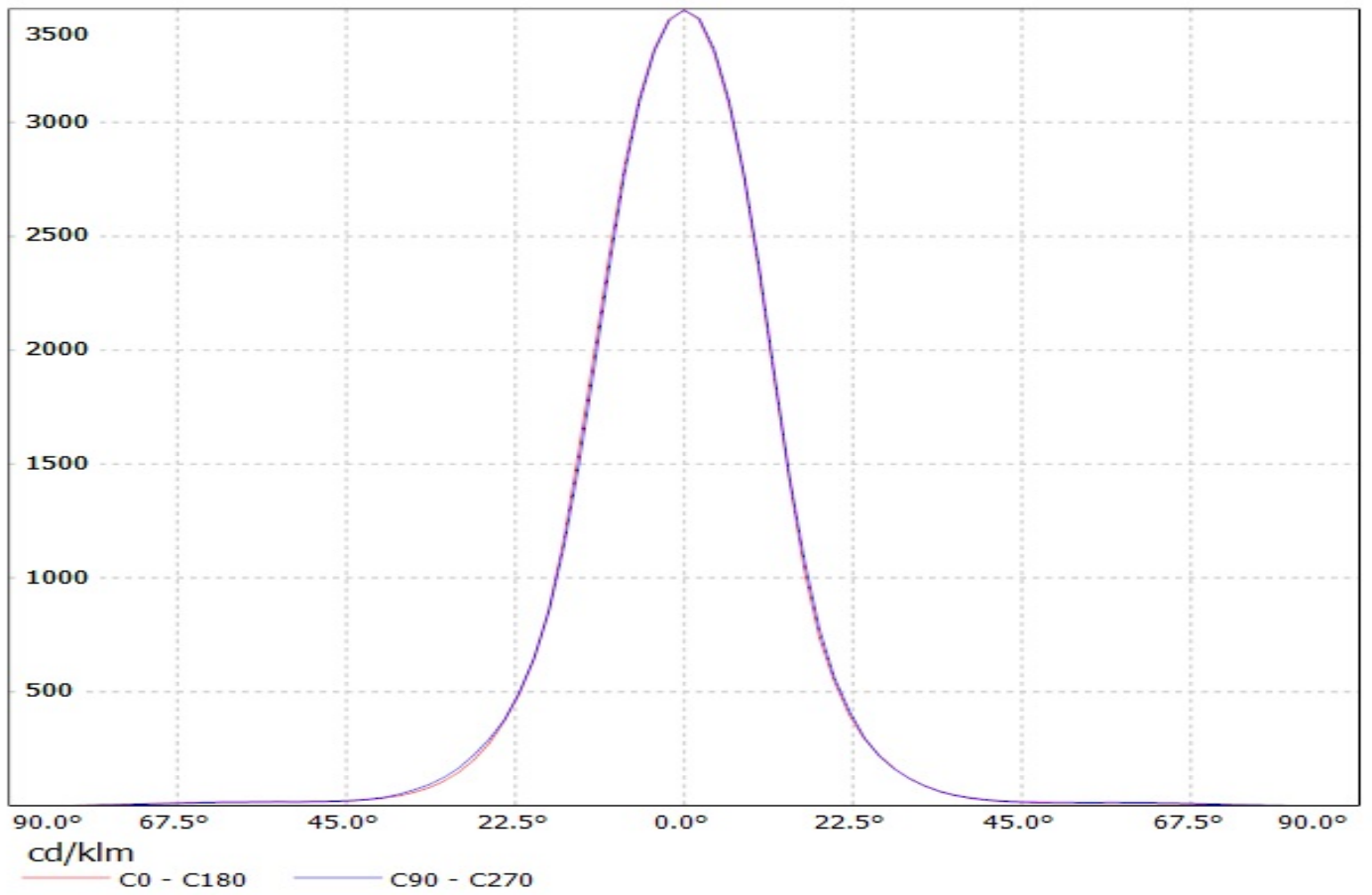

Luminaire: Ledil Oy FP13028\_LISA2-M-PIN\_Seoul\_Z8Y22P\_SIMULATED  
Lamps: 1 x Seoul Z8Y22P

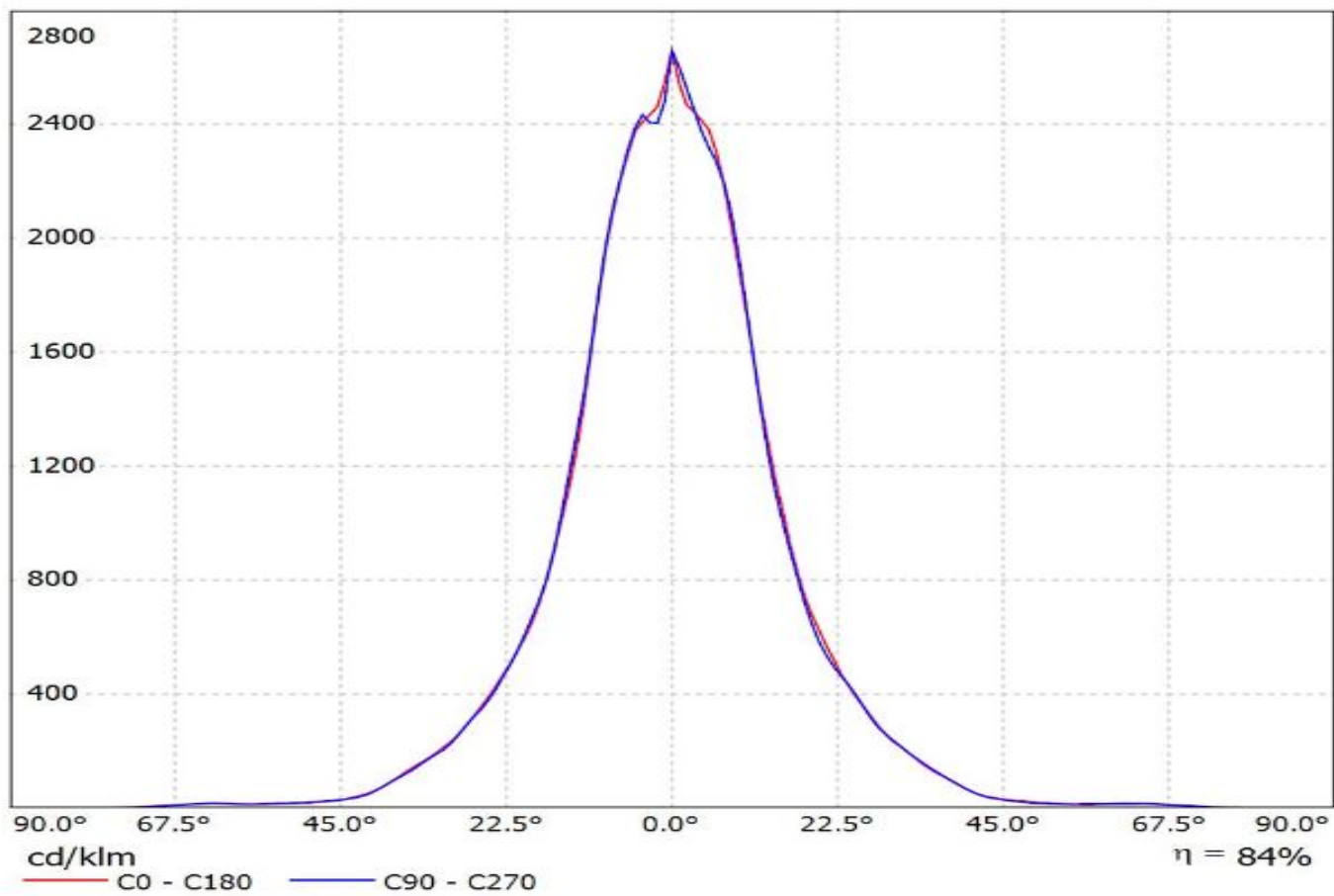



Luminaire: LEDiL Oy FP13030&FP13028\_LISA2-M\_PIN&CLIP Ef. 89%  
Lamps: 1 x Cree XT-E 104lm@250mA CCT=5000K P=0.77W I=250mA

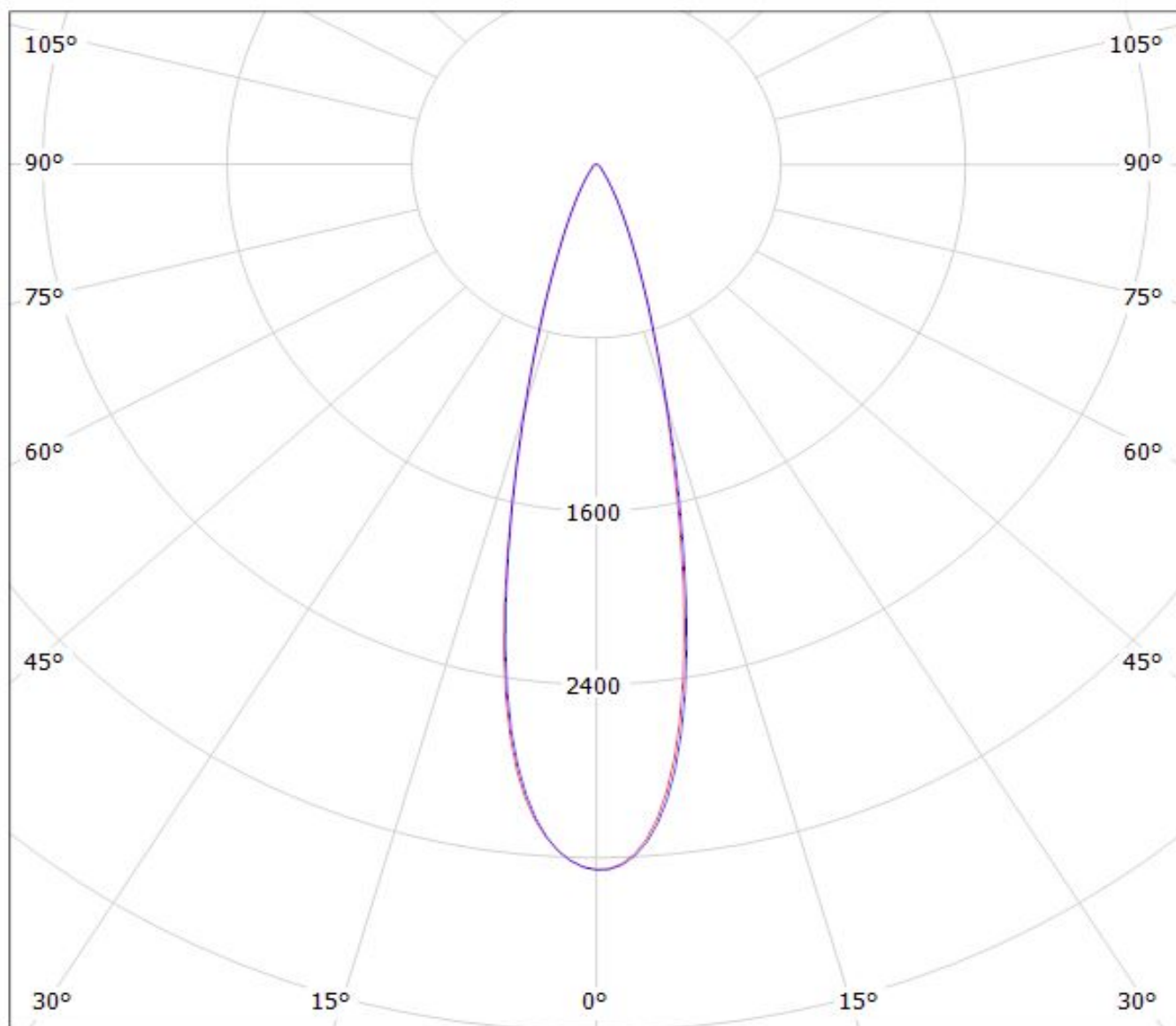

cd/klm

$\eta = 89\%$

— C0 - C180

— C90 - C270

Luminaire: LEDiL Oy FP13028&FP13030\_LISA2-M\_(XP-G2) Eff. 89%  
Lamps: 1 x Cree\_(XP-G2) 104lm@250mA CCT=6600K P=0.76W I=250mA

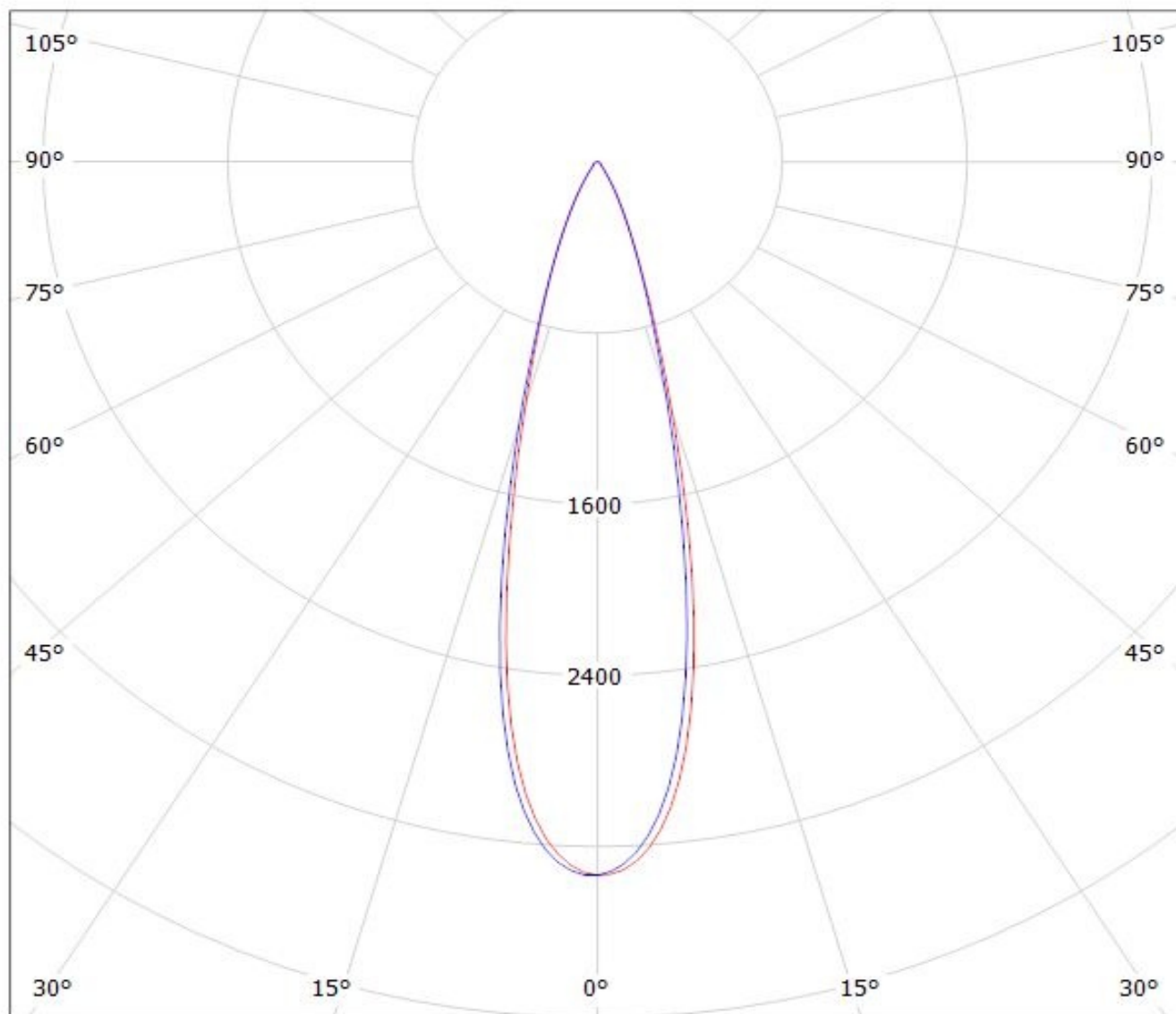

cd/klm

— C0 - C180 — C90 - C270

Luminaire: Ledil Oy  
Lamps: 1 x

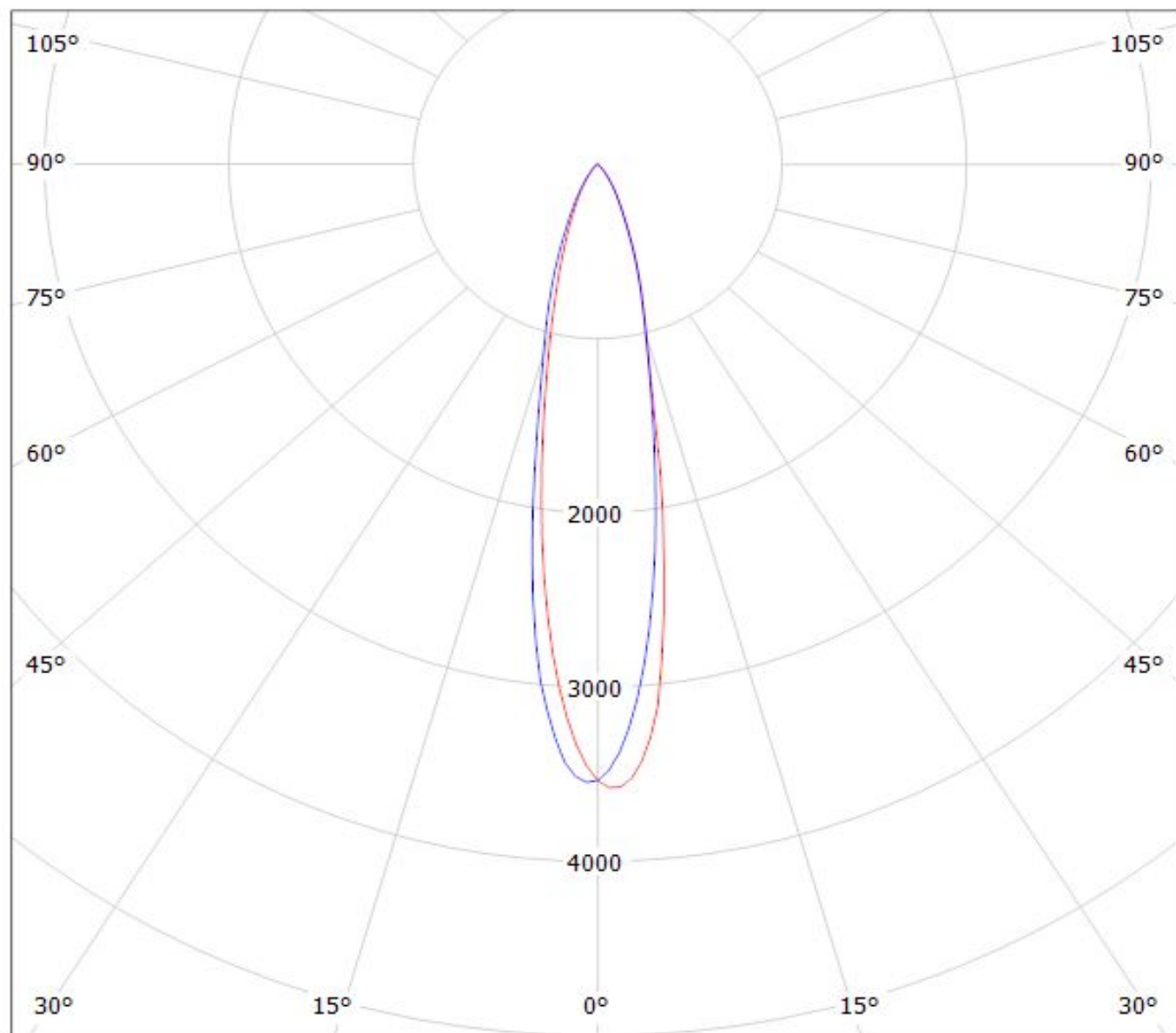

cd/klm

— C0 - C180

— C90 - C270

$\eta = 84\%$

Luminaire: LEDiL Oy FP13030&FP13028\_LISA2-M\_(CLIP&PIN) Eff.86.6%  
Lamps: 1 x LUXEON\_T (74lm@250mA)

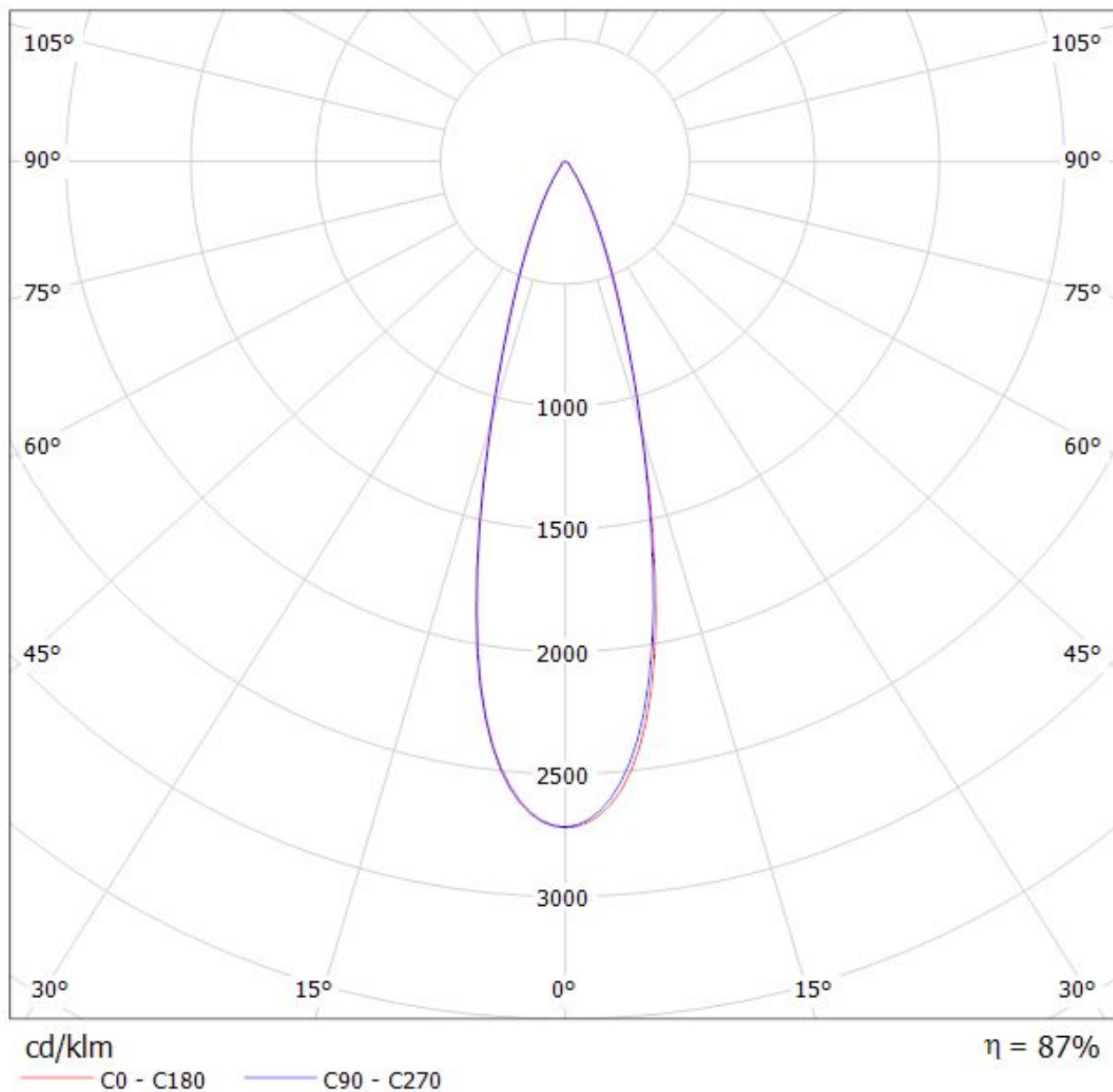

Luminaire: Ledil Oy FP13028\_LISA2-M-PIN\_(Luxeon\_TX) Efficiency=88%  
Lamps: 1 x Luxeon TX (L1T2-3585) 108lm @ 250mA CCT=3521K P=0.73W I=250mA

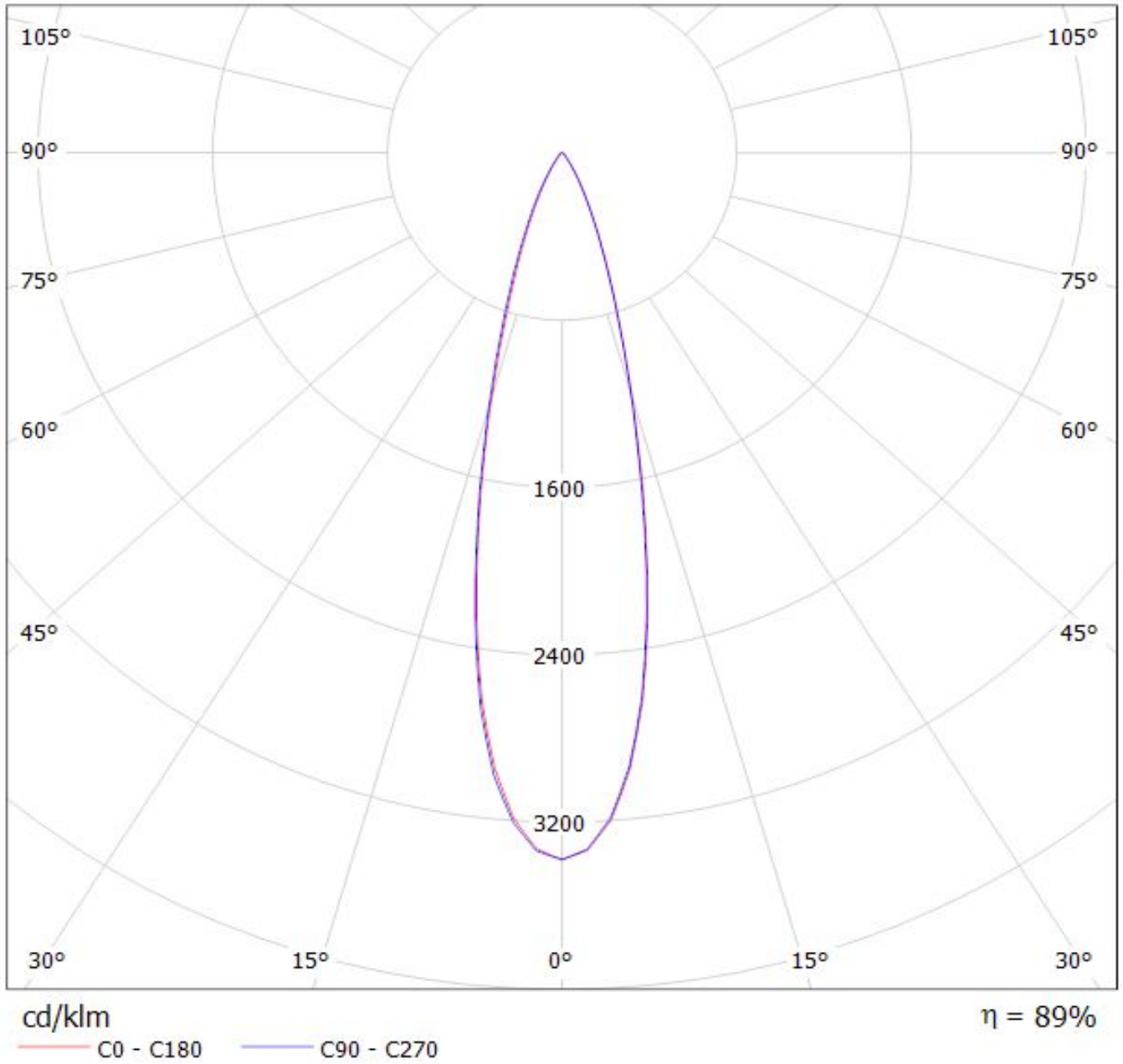

Luminaire: Ledil Oy FP13028\_LISA2-M-PIN\_(NCSxx19B) Efficiency=85%

Lamps: 1 x Nichia NCSxx19B (NCSL119BE) 88lm @ 250mA CCT=3000K P=0.8W I=250mA

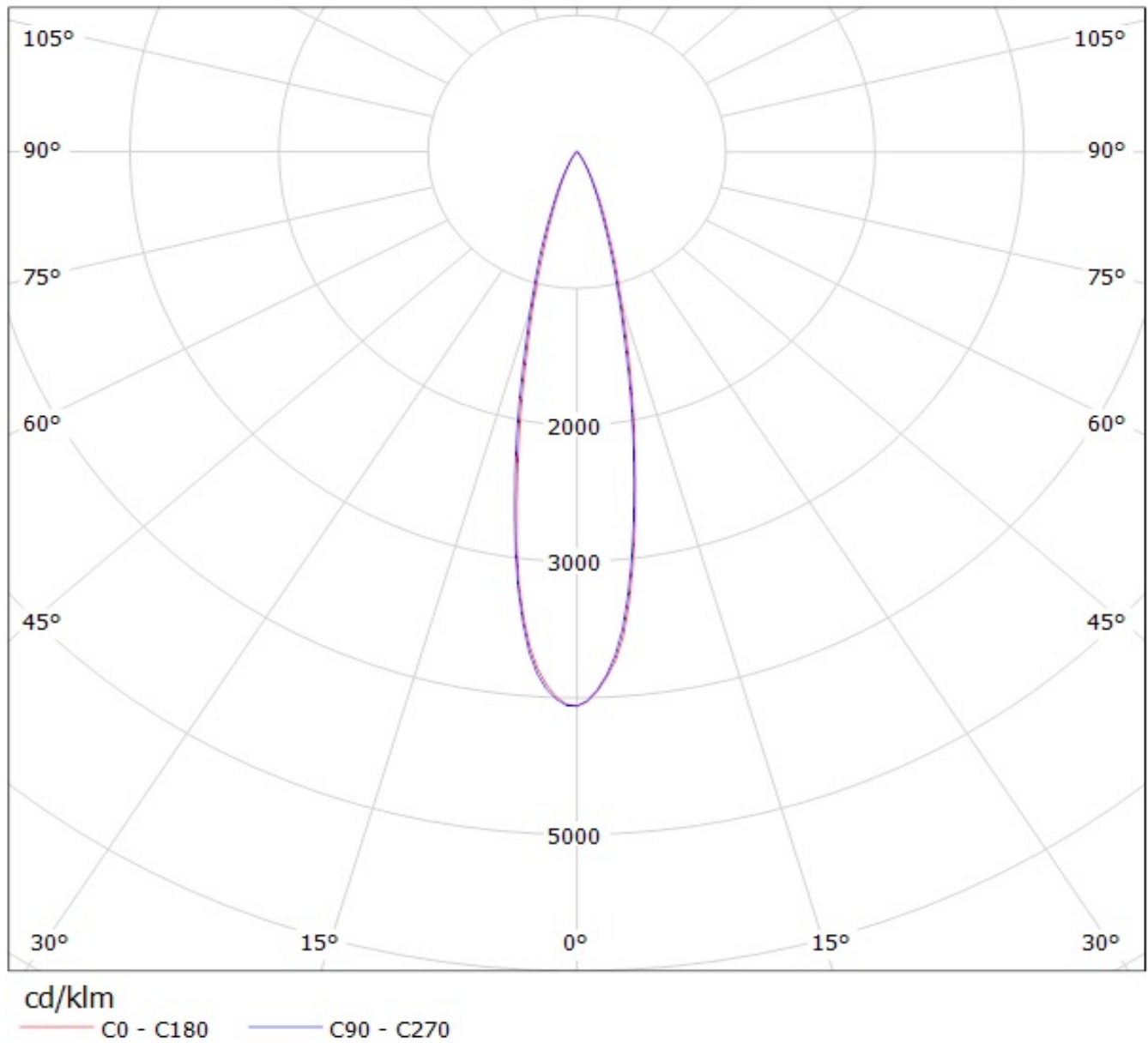

Luminaire: LEDiL Oy FP13028\_LISA2-M-PIN\_(NVSL219CE)  
Lamps: 1 x Nichia\_NVSL219CE\_101.052lm@250mA\_P=0.713154W\_I=0.25A

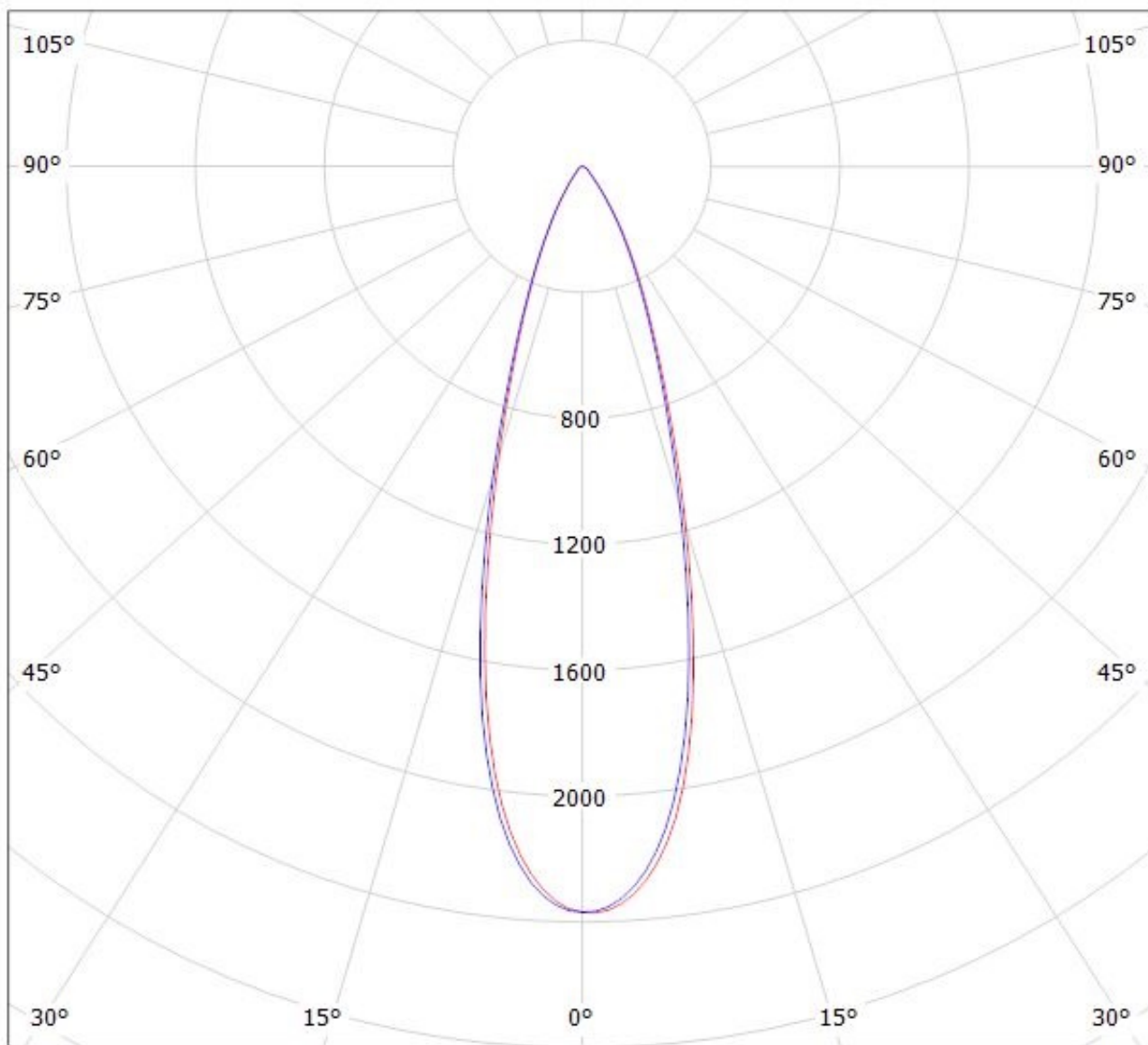

cd/klm

— C0 - C180    — C90 - C270

$\eta = 86\%$

Luminaire: LEDiL Oy  
Lamps: 1 x FP13028\_LISA2-M-PIN\_(SQ)

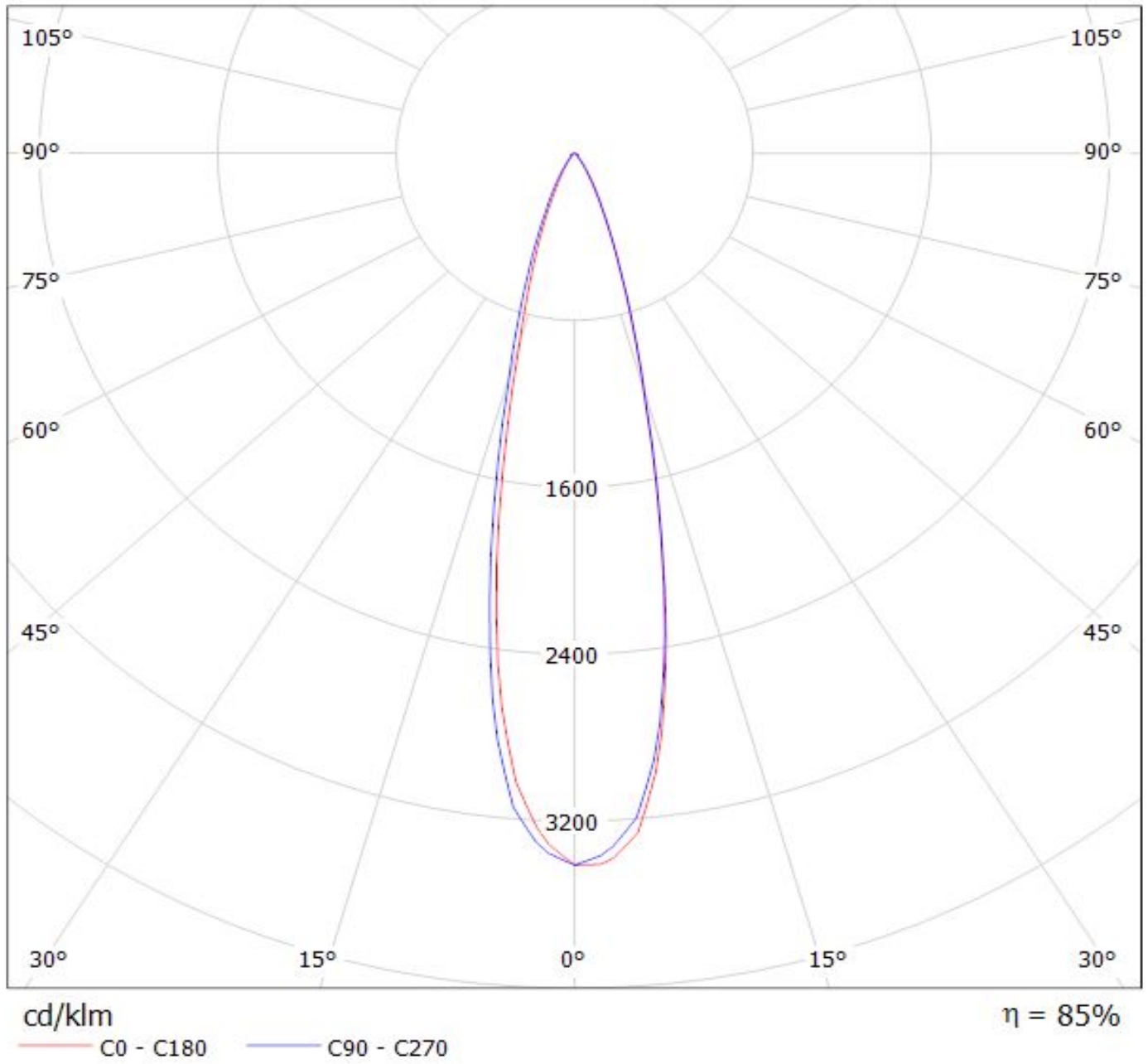



Luminaire: Ledil Oy FP13028\_LISA2-M-PIN\_(SFH\_4715AS)\_SIMULATED  
Lamps: 1 x Osram SFH 4715AS

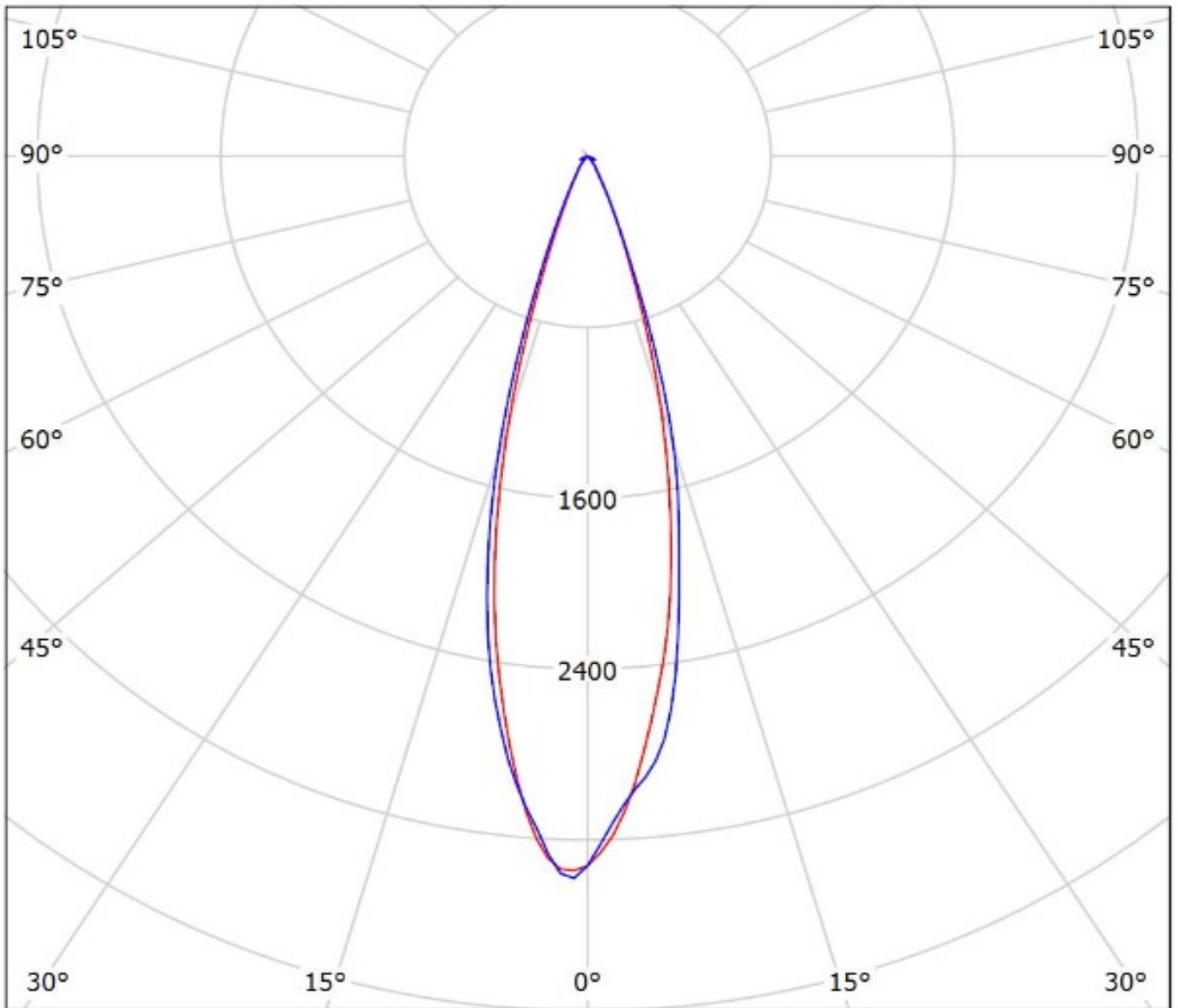

cd/klm

— C0 - C180 — C90 - C270

$\eta = 89\%$

Luminaire: Ledil Oy FP13028\_LISA2-M-PIN\_(LH351Z) Efficiency=87%  
Lamps: 1 x Samsung LH351Z (90.14lm @ 250mA) CCT=6500K P=0.7W I=250mA

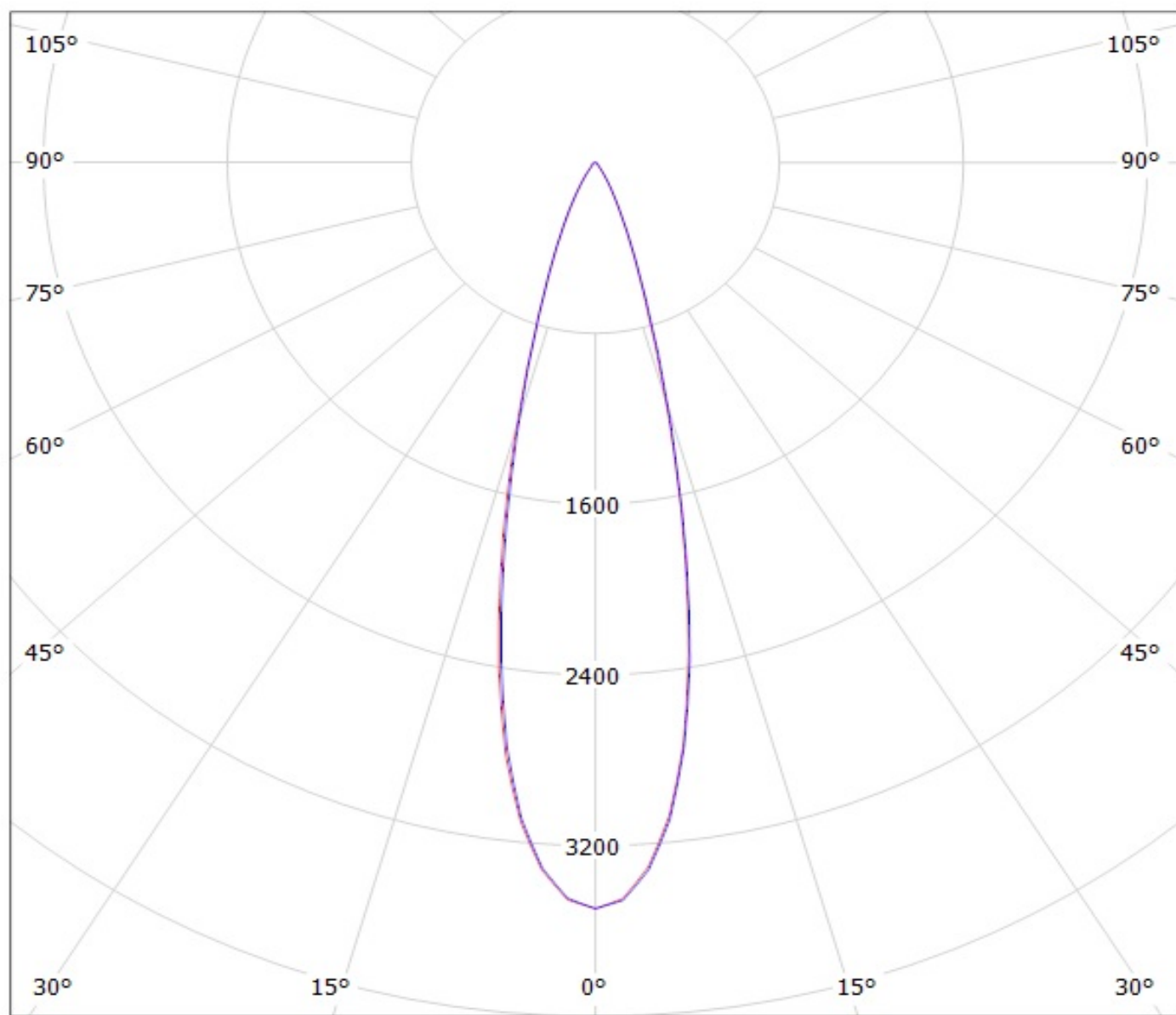

cd/klm

— C0 - C180 — C90 - C270

Luminaire: Ledil Oy FP13028\_LISA2-M-PIN\_Seoul\_Z8Y22P\_SIMULATED  
Lamps: 1 x Seoul Z8Y22P

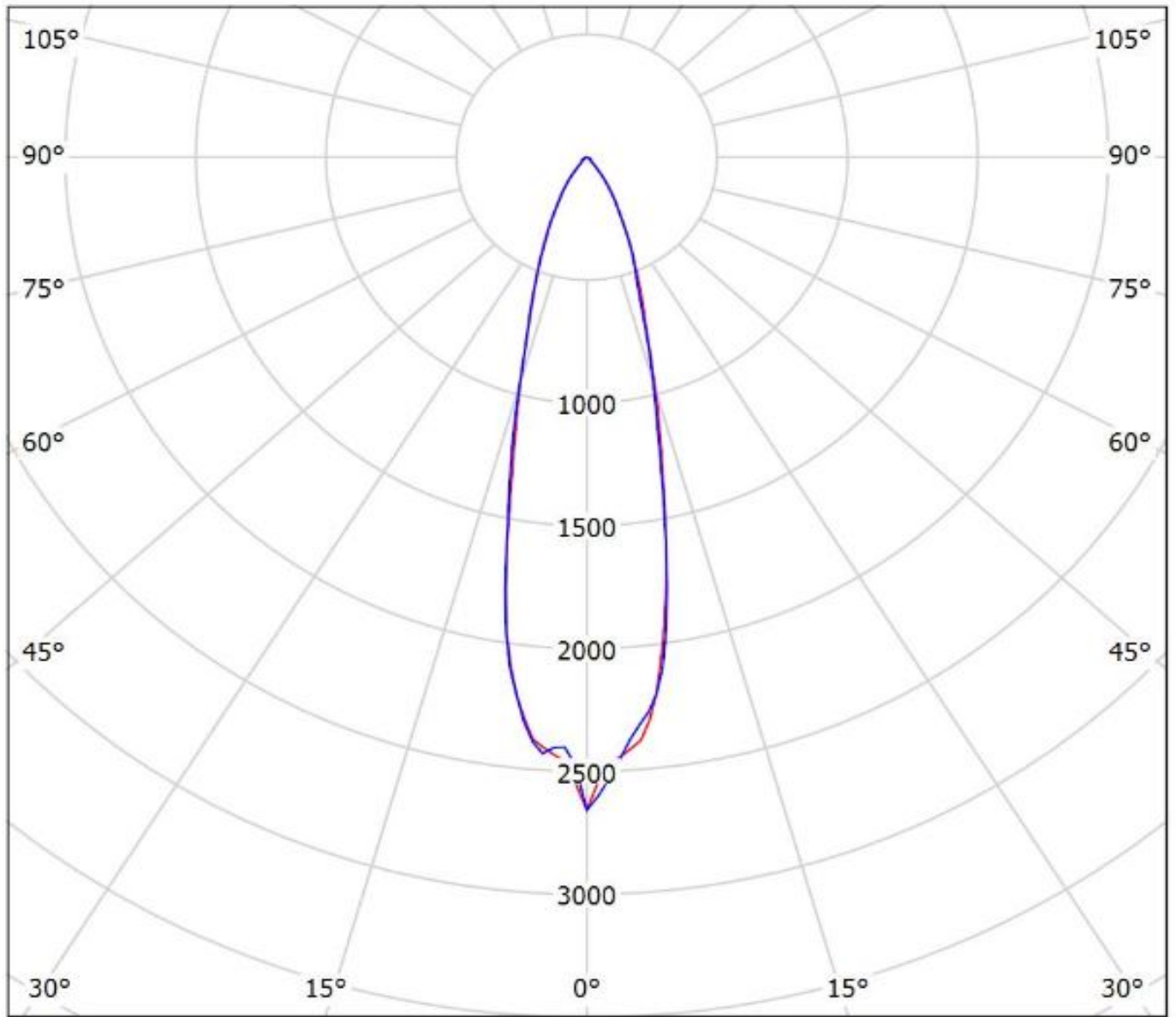

cd/klm

— C0 - C180 — C90 - C270

$\eta = 84\%$

**NOTE: The typical divergence will be changed by different color, chip size and chip position tolerance. The typical total divergence is the full angle measured where the luminous intensity is half of the peak value.**