

**SF1059A**

**350.0 MHz  
SAW Filter**

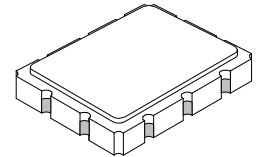

**SM9171-10**

- **Low Loss UHF SAW Filter**
- **9.1 x 7.1 mm Version of SF1059A-1**
- **Single-ended or Balanced Operation**
- **Complies with Directive 2002/95/EC (RoHS)**



**Absolute Maximum Ratings**

Rating	Value	Units
Maximum Incident Power in Passband	+10	dBm
Maximum DC Voltage Between any 2 Terminals	30	VDC
Storage Temperature Range	-40 to +85	°C
Suitable for lead-free soldering - Maximum Soldering Profile	260 °C for 30 s	

**Electrical Characteristics**

Characteristic	Sym	Notes	Min	Typ	Max	Units
Nominal Center Frequency	$f_C$	1	350.00			MHz
Passband:	IL			8	10.0	dB
Insertion Loss at $f_C$						
3 dB Passband	$BW_3$	1, 2	±400	±600		kHz
Amplitude Variation over $f_C \pm 250$ kHz				0.5	1.0	dB <sub>P-P</sub>
Group Delay Variation over $f_C \pm 400$ kHz	GDV			200	250	ns <sub>P-P</sub>
Rejection referenced to IL:		1, 2, 3	35	40		dB
( $f_C - 8.0$ ) to ( $f_C - 2.0$ ) and ( $f_C + 2.0$ ) to ( $f_C + 8.0$ ) MHz						
( $f_C - 50$ ) to ( $f_C - 8.0$ ) and ( $f_C + 8.0$ ) to ( $f_C + 50$ ) MHz			40	45		
Ultimate Rejection				50		
Operating Temperature Range	$T_A$	1	-20		+70	°C
Impedance Matching to 50 $\Omega$ unbalanced	External L-C					
Case Style	SM9171-10 9.1 x 7.1 mm Nominal Footprint					
Lid Symbolization (YY=year, WW=week, S=shift, ##=sequence code)	RFM SF1059A <u>YYWWS##</u>					

 **CAUTION: Electrostatic Sensitive Device. Observe precautions for handling.**

**NOTES:**

1. Unless noted otherwise, all specification apply over the operating temperature range with filter soldered to the specified demonstration board with impedance matching to 50  $\Omega$  network analyzer.
2. Unless noted otherwise, all frequency specifications are referenced to the nominal center frequency,  $f_C$ .
3. Rejection is measured as attenuation below the minimum IL point in the passband. Rejection in final user application is dependent on PCB layout and external impedance matching design. See Application Note No. 42 for details.
4. "LRIP" or "L" after the part number indicates "low rate initial production" and "ENG" or "E" indicates "engineering prototypes."
5. The design, manufacturing process, and specifications of this filter are subject to change.
6. Either Port 1 or Port 2 may be used for either input or output in the design. However, impedances and impedance matching may vary between Port 1 and Port 2, so that the filter must always be installed in one direction per the circuit design.
7. US and international patents may apply.
8. Murata, stylized Murata logo, and Murata N.A., Inc. are registered trademarks of Murata Manufacturing Co., Ltd.

# SF1059A Filter Plots

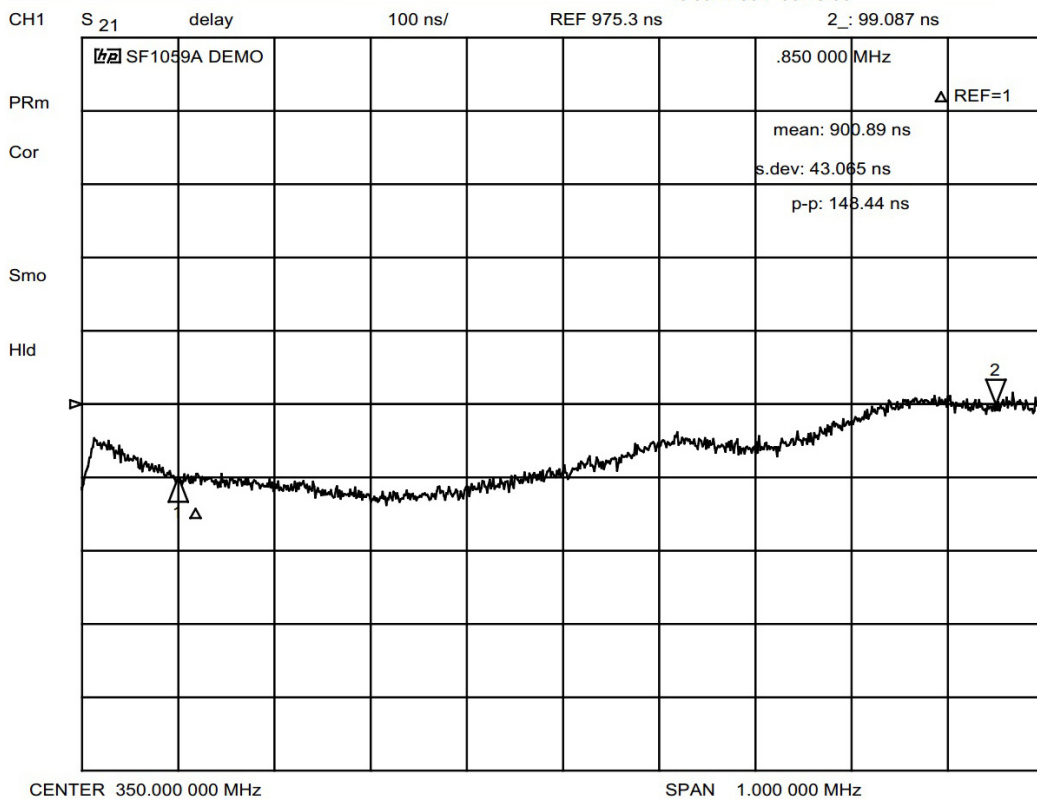
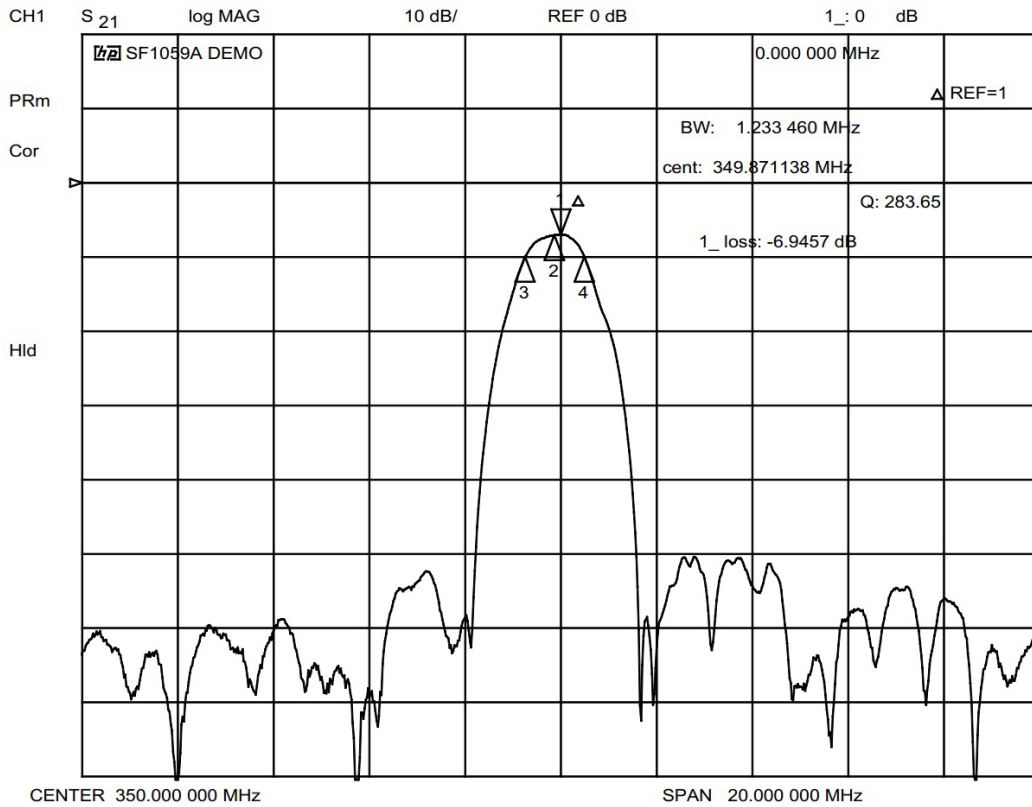

## SF1059A Impedance Plots

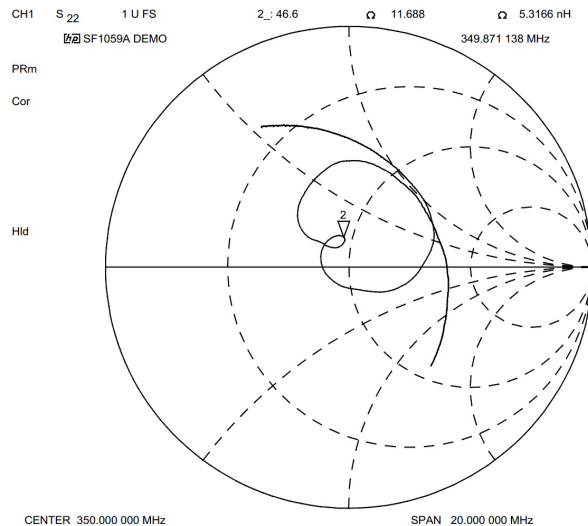
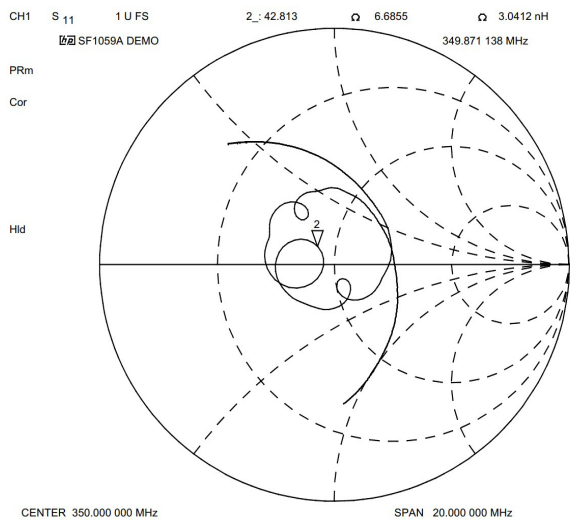

## SF1059A Typical Tuning Network

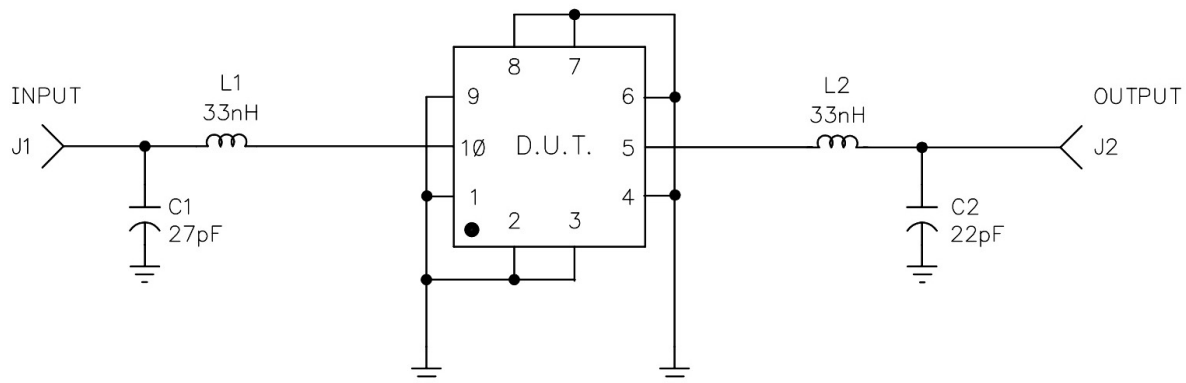

# SM9171-10 Case

10-Terminal Ceramic Surface-Mount Case  
9.1 x 7.1 mm Nominal Footprint

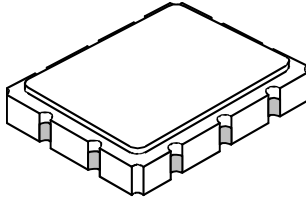

Case Dimensions						
Dimension	mm			Inches		
	Min	Nom	Max	Min	Nom	Max
A	8.86	9.09	9.40	0.349	0.358	0.370
B	6.88	7.11	7.40	0.271	0.280	0.291
C		1.91	2.00		0.075	0.079
D		0.99			0.039	
E		0.79			0.031	
H		1.0			0.039	
P		2.54			0.100	

Materials	
Solder Pad Plating	0.3 to 1.0 $\mu\text{m}$ Gold over 1.27 to 8.89 $\mu\text{m}$ Nickel
Lid Plating	2.0 to 3.0 $\mu\text{m}$ Nickel
Body	$\text{Al}_2\text{O}_3$ Ceramic
Pb Free	

Electrical Connections		
Connection		Terminals
Port 1	Input or Return	5
	Return or Input	6
Port 2	Output or Return	10
	Return or Output	1
Ground		All others
For Single-ended Operation		Ground 1, 6

