

ILB S3 24 DI16 DIO16-2TX

Inline Block IO Module for
SERCOS III With 16 Digital Inputs and
16 Digital Inputs/Outputs

AUTOMATIONWORX

Data Sheet
7606_en_00

© PHOENIX CONTACT - 09/2007

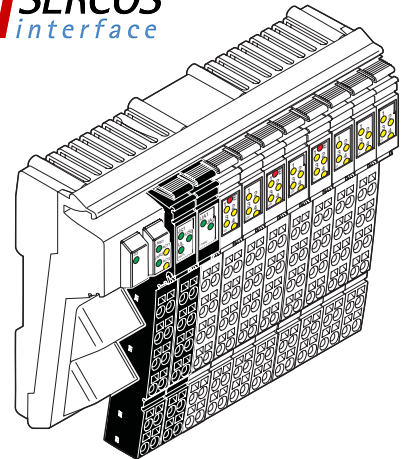

Description

The ILB S3 24 DI16 DIO16-2TX module is designed for use within a SERCOS III network. It is used to acquire digital input signals and output digital signals.

Features of SERCOS III

- 2 x Ethernet twisted pair according to 802.3u with auto negotiation and auto crossing, connected via an integrated managed 3-port switch (2 external ports, 1 internal port)
- Transmission speed of 100 Mbps

Features of Inputs

- Connections for 16 digital sensors
- Connection of sensors in 2 and 3-wire technology
- Maximum permissible load current per sensor: 125 mA
- Maximum permissible load current from the sensor supply: 2.0 A

Features of Combined Inputs or Outputs

- Connections for 16 digital sensors/actuators
- Each individual channel can be used as an input or an output
- Connection of sensors in 2 and 3-wire technology
- Maximum permissible load current per sensor: 125 mA
- Maximum permissible load current from the sensor supply: 2.0 A
- Connection of actuators in 2-wire technology
- Nominal current per output: 0.5 A
- Total current of all outputs: 8 A
- Short-circuit and overload protected outputs



Please refer to the "Assembly and Removal of Inline Block IO Modules" application note (see "Documentation" on page 2).



Make sure you always use the latest documentation.
It can be downloaded at www.download.phoenixcontact.com.
A conversion table is available on the Internet at
www.download.phoenixcontact.com/general/7000_en_00.pdf.

Ordering Data

Product

Description	Type	Order No.	Pcs./Pck.
Inline Block IO module for SERCOS III with 16 digital inputs and 16 digital inputs/outputs	ILB S3 24 DI16 DIO16-2TX	2897570	1

Accessories: Ethernet

Description	Type	Order No.	Pcs./Pck.
Gray RJ45 connector set for linear cable	FL PLUG RJ45 GR/2	2744856	2
Green RJ45 connector set for crossed cable	FL PLUG RJ45 GN/2	2744571	2
Double sheathed Ethernet cable	FL CAT5 HEAVY	2744814	1
Stranded Ethernet cable	FL CAT5 FLEX	2744830	1
Assembly tool for RJ45 connector	FL CRIMPTOOL	2744869	1



Matching dust protection covers and safety systems for RJ45 connections can be found in the product range from Reichle & De-Massari AG/Switzerland.

Accessories: Other

Description	Type	Order No.	Pcs./Pck.
End clamp for securing the module on the DIN rail for a horizontal mounting position; to the right and left of the module	CLIPFIX 35	3022218	50
End clamp for securing the module on the DIN rail for a vertical mounting position; above and below the module	E/AL-NS 35	1201662	10

Documentation

Description	Type	Order No.	Pcs./Pck.
"Assembly and Removal of Inline Block IO Modules" application note	AH ILB INSTALLATION	9014931	1

Technical Data

General Data

Housing dimensions with connectors (width x height x depth)	156 mm x 55 mm x 141 mm
Weight	500 g (with connectors)
Operating mode	Process data mode with 2 words
Transmission speed	100 Mbps with auto negotiation and auto crossing
Connection method for sensors and actuators	2 and 3-wire technology
Regulations	Developed according to VDE 0160/EN 50178/IEC 62103
Ambient temperature (operation)	-25°C to +60°C
Ambient temperature (storage/transport)	-25°C to +85°C
Permissible humidity (operation/storage/transport)	10% to 95%, according to EN 61131-2
Permissible air pressure (operation/storage/transport)	70 kPa to 108 kPa (up to 3000 m above sea level)
Degree of protection according to IEC 60529	IP20
Protection class	Class 3 according to EN 61113-2, IEC 61113-2
Connection data for Inline connectors	
Connection method	Spring-cage terminals
Conductor cross-section	0.2 mm ² to 1.5 mm ² (solid or stranded), 24 - 16 AWG
Air and creepage distances	According to DIN VDE 0110/IEC 60664, IEC 60664A, DIN VDE 0160/EN 50178/IEC 62103
Housing material	Plastic, PVC-free, PBT, self-extinguishing (V0)
Pollution degree according to EN 60664-1/IEC 60664-1, EN 61131-2/IEC 61131-2	2; condensation not permitted during operation
Surge voltage category	II

Housing Dimensions

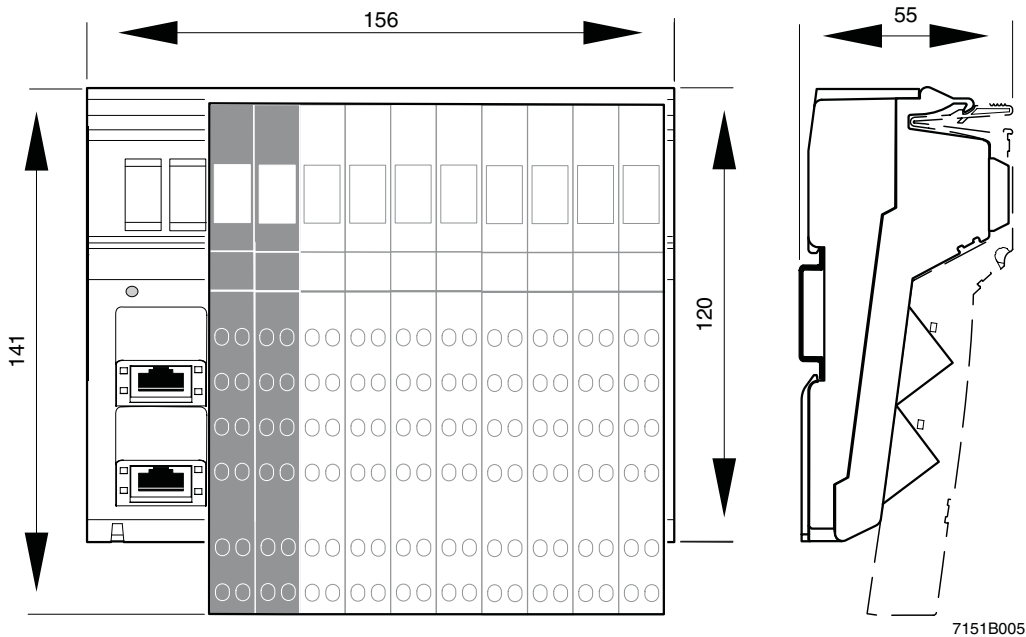

Figure 1 Module housing dimensions (in mm)

Electrical Isolation/Isolation of the Voltage Areas

Test Distance

- I/O/logic
- I/O/functional earth ground
- Logic/functional earth ground
- Ethernet interface signals/logic

Test Voltage

- 500 V AC, 50 Hz, 1 min.
- 500 V AC, 50 Hz, 1 min.
- 500 V AC, 50 Hz, 1 min.
- 1500 V rms, 50 Hz to 60 Hz, 1 min.

Mechanical Requirements

- Vibration test sinusoidal vibrations according to EN 60068-2-6/IEC 60068-2-6: 5g load, 2.5 hours in each space direction
- Shock test according to EN 60068-2-27/IEC 60068-2-27: 25g load for 11 ms, half sinusoidal wave, 3 shocks in each space direction and orientation
- Broadband noise according to EN 60068-2-64/IEC 60068-2-64: 0.78g load, 2.5 hours in each space direction

Conformance With EMC Directive 89/336/EEC and 2004/108/EC

Noise Immunity Test According to EN 61000-6-2

Electrostatic discharge (ESD)	EN 61000-4-2 IEC 61000-4-2	Criterion B 4 kV contact discharge 8 kV air discharge
Electromagnetic fields	EN 61000-4-3 IEC 61000-4-3	Criterion A Field strength: 10 V/m
Fast transients (burst)	EN 61000-4-4 IEC 61000-4-4	Criterion B Remote bus: 2 kV Power supply: 2 kV I/O cables: 2 kV Criterion A All interfaces: 1 kV
Surge voltage	EN 61000-4-5 IEC 61000-4-5	Criterion B DC supply lines: ± 0.5 kV/ ± 0.5 kV (symmetrical/asymmetrical) Signal lines: ± 1 kV/ ± 1 kV (symmetrical/asymmetrical)
Conducted interference	EN 61000-4-6 IEC 61000-4-6	Criterion A Test voltage 10 V

Noise Emission Test According to EN 61000-6-4

Noise emission of housing	EN 55011	Class A
---------------------------	----------	---------

Interface

SERCOS III interface	2 x SERCOS III via RJ45 connectors; Shielding via parallel connection of R, C, and VDR
----------------------	---

24 V Module Supply (Logic, Sensor, and Actuator Supply)

Nominal value	24 V DC
Tolerance	-15%/+20% according to EN 61131-2
Ripple	$\pm 5\%$ according to EN 61131-2
Permissible range	19.2 V to 30 V
Current consumption at U_L	90 mA
Safety equipment	Surge protection and protection against polarity reversal
Connection	Via power connectors

Digital Outputs

Number	16 (can be freely selected)
Connection method for actuators	2-wire technology
Nominal output voltage U_{OUT}	24 V DC
Differential voltage for I_{nom}	≤ 1 V
Nominal current I_{nom} per channel	0.5 A
Total current	8 A
Protection	Short circuit; overload
Delay time	
t_{ON}	Approximately 40 μ s, typical; 200 μ s, maximum
t_{OFF}	Approximately 150 μ s, typical; 400 μ s, maximum
Nominal load	
Ohmic	48 Ω /12 W
Lamp	12 W
Inductive	12 VA (1.2 H, 50 Ω)
Switching frequency with nominal inductive load	0.5 Hz (1.2 H, 50 Ω), maximum
Overload response	Auto restart
Response with inductive overload	Output may be damaged
Reverse voltage protection against short pulses	Protected against reverse voltages
Resistance to permanently applied reverse voltages	Protected against reverse voltages, permissible current 2 A, maximum
Response upon power down	The output follows the supply voltage without delay

Digital Outputs (Continued)

Limitation of the voltage induced on circuit interruption	-41.0 V
Single maximum energy in free running	1 J, maximum
Protective circuit type	Integrated free running circuit in the output chip
Overcurrent shutdown	0.7 A, minimum
Maximum output current when switched off	10 µA



When not loaded, a voltage can be measured even at an output that is not set.

Error message sent to the higher-level control system

Short circuit/overload of outputs

Digital Inputs

Number	32 (16 fixed, 16 can be freely selected)
Connection method for sensors	2 and 3-wire technology
Input design	According to EN 61131-2 Type 1
Definition of switching thresholds	
Maximum low-level voltage	$U_{Lmax} < 5 V$
Minimum high-level voltage	$U_{Hmin} > 15 V$
Common potentials	Sensor supply U_S , ground
Nominal input voltage U_{IN}	24 V DC
Permissible range	$-30 V < U_{IN} < +30 V$ DC
Nominal input current for U_{IN}	5 mA, typical
Current flow	Linear in the range $1 V < U_{IN} < 30 V$
Delay time	
t_{ON}	Approximately 50 µs, typical; 100 µs, maximum
t_{OFF}	Approximately 145 µs, typical; 400 µs, maximum
Permissible cable length to the sensor	100 m
Use of AC sensors	AC sensors in the voltage range $< U_{IN}$ are limited in application
Error message sent to the higher-level control system	Sensor supply not present Sensor supply short circuit/overload

Power Dissipation

Formula to Calculate the Power Dissipation of the Electronics

$$P_{TOT} = 1.68 W + (I_{S36}^2 + I_{S710}^2) \times 0.06 \Omega + \sum_{n=1}^{16} (0.129 W + I_{Ln}^2 \times 0.28 \Omega + I_{Ln} \times 0.35 V) + \sum_{m=1}^{32} 0.125 W$$

Where

P_{TOT}	Total power dissipation of the module
n	Index of the number of set outputs (n = 1 to 16)
I_{Ln}	Load current of output n
m	Index of the number of set inputs (m = 1 to 32)
I_{S36}	Current from the sensor supply at slots 3 to 6
I_{S710}	Current from the sensor supply at slots 7 to 10

Limitation of Simultaneity

No limitation of simultaneity, derating

Derating

Ambient Temperature (T_A)	Total Current (I_{TOT})
Outputs, Connectors 3 to 6	
-25°C to +30°C	8 A
+30°C to +60°C	$8\text{ A} - ((T_A - 30^\circ\text{C}) \times 0.2\text{ A}/^\circ\text{C})$

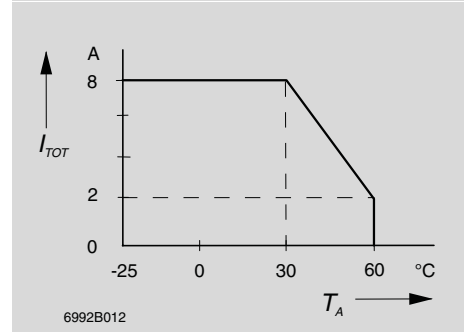

Sensor Supply, Connectors 3 to 6	
-25°C to +30°C	2 A
+30°C to +60°C	$2\text{ A} - ((T_A - 30^\circ\text{C}) \times 0.05\text{ A}/^\circ\text{C})$

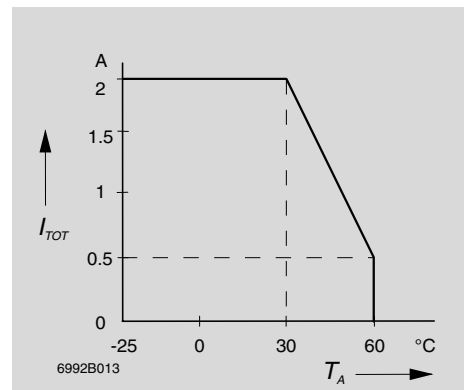

Sensor Supply, Connectors 7 to 10	
-25°C to +30°C	2 A
+30°C to +60°C	$2\text{ A} - ((T_A - 30^\circ\text{C}) \times 0.05\text{ A}/^\circ\text{C})$

Approvals

For the latest approvals, please visit www.download.phoenixcontact.com or eshop.phoenixcontact.com.



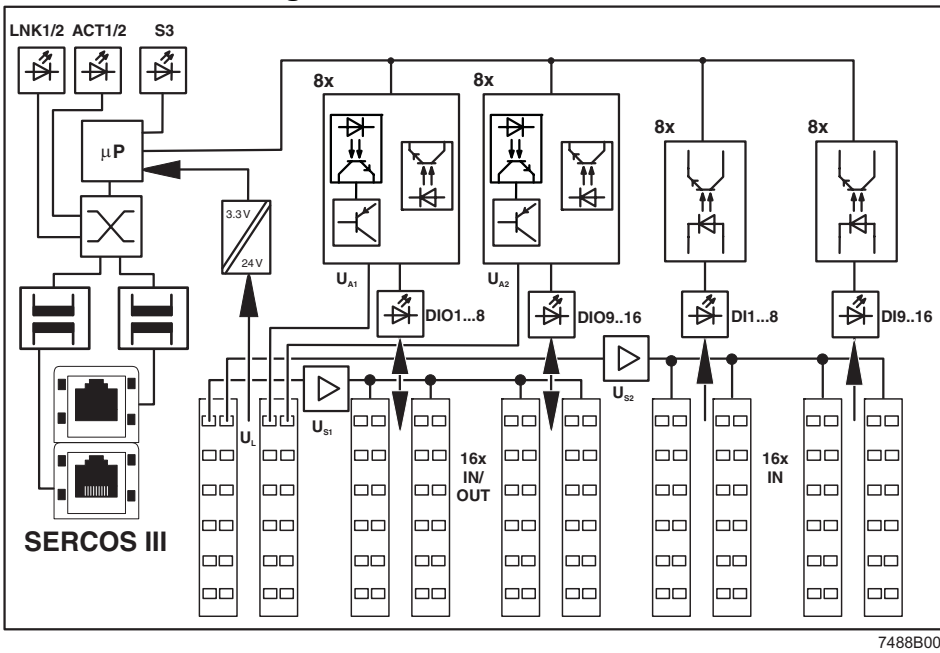



Internal Circuit Diagram



7488B004

Figure 2 Internal wiring of the terminal points

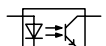
Key:

-  LED
-  Microprocessor
-  Switch
-  Transmitter
-  Electrical isolation
-  Optocoupler
-  Short-circuit-proof sensor supply

Relevant Notes



Shielding

The shielding ground of the connected twisted pair cables is electrically connected to FE. When connecting network segments, avoid ground loops, potential transfers, and voltage equalization currents via the braided shield.



Electrostatic discharge

The module contains components that can be damaged or destroyed by electrostatic discharge. When handling this module, observe the necessary safety precautions against electrostatic discharge (ESD) according to EN 61340-5-1 and EN 61340-5-2, as well as IEC 61340-5-1 and IEC 61340-5-2..



Housing

Only personnel authorized by Phoenix Contact are permitted to open the housing.

Local Diagnostic and Status Indicators

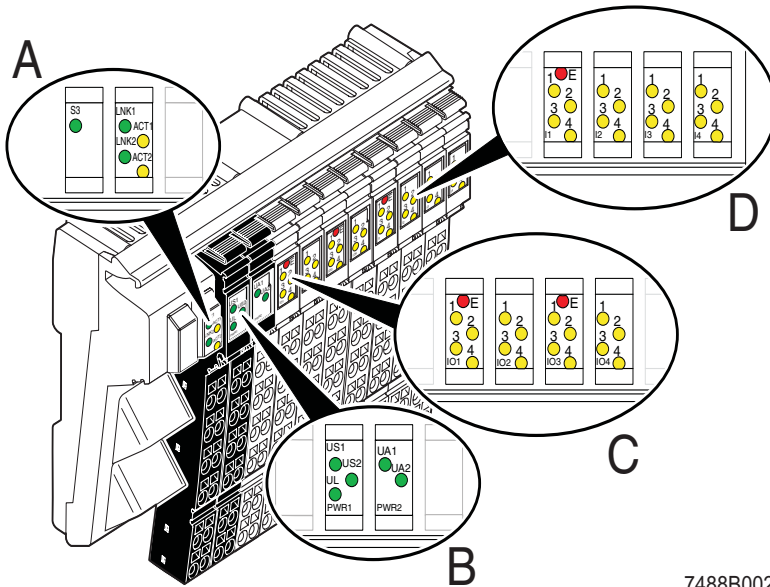

7488B002

Figure 3 Local diagnostic and status indicators

Designation	Color	Meaning
A: SERCOS III		
S3	Green	
	ON	CP4 no error
	Flashing, 4 Hz	Loop back activated
	Red	
	ON	SIII C1D (Class 1 diagnostics)
	Flashing, 4 Hz	Communication error (S-0-1003)
	Orange	
ON	CP0 ... CP3	
Flashing, 4 Hz	Identification (bit 15 in interface control) Used for address assignment and configuration errors.	
OFF	24 V communications power not present or no SERCOS III communication	
LNK1/2	Green	Link1/2
	ON	Connection via Ethernet to a module via port 1/2 established
ACT1/2	Yellow	Activity1/2
	ON	If the yellow LED is on, this indicates transmission or reception of a telegram at port 1/2
B: PWR 1/PWR 2		
US1/2	Green	Sensor supply 1/2
	ON	Sensor supply 1/2 present
	OFF	Sensor supply 1/2 not present
UA1/2	Green	Actuator supply 1/2
	ON	Actuator supply 1/2 present
	OFF	Actuator supply 1/2 not present

Designation	Color	Meaning
UL	Green	24 V communications power
	ON	24 V communications power present
	OFF	24 V communications power not present
C: IO1 ... IO4		
E	Red	Output error message (see note below)
	ON	Short circuit or overload of outputs
	OFF	No output error
1 ... 4	Yellow	Status of the inputs/outputs
	ON	Input/output active
	OFF	Input/output not active
D: I1 ... I4		
E	Red	Sensor supply error
	ON	Short circuit or overload of one of the sensor supplies
	OFF	No sensor supply error
1 ... 4	Yellow	Status indicators of the inputs
	ON	Input active
	OFF	Input not active



If the error LED (E) of a group of eight outputs lights up (connector 3/4 or connector 5/6), this indicates that a short circuit or overload is present at one or more of the outputs in this group.

Connection of SERCOS III, Supply, Inputs, and Outputs

Connection of SERCOS III

By default upon delivery, the Ethernet connections have been set to auto negotiation with auto crossing. The module can be connected using, e.g., a 1:1 cable or a crossover cable.



For additional information about Ethernet cabling, please refer to www.iaona-eu.com.

Connect SERCOS III to the module via an 8-pos. RJ45 connector. For the pin assignment of the female connector, please refer to the following table:

Pin	Assignment
1	TD+ (transmit data +)
2	TD- (transmit data -)
3	RD+ (receive data +)
4	Reserved
5	Reserved
6	RD- (receive data -)
7	Reserved
8	Reserved

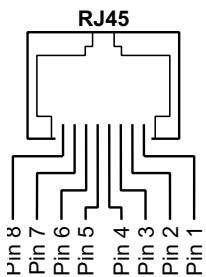
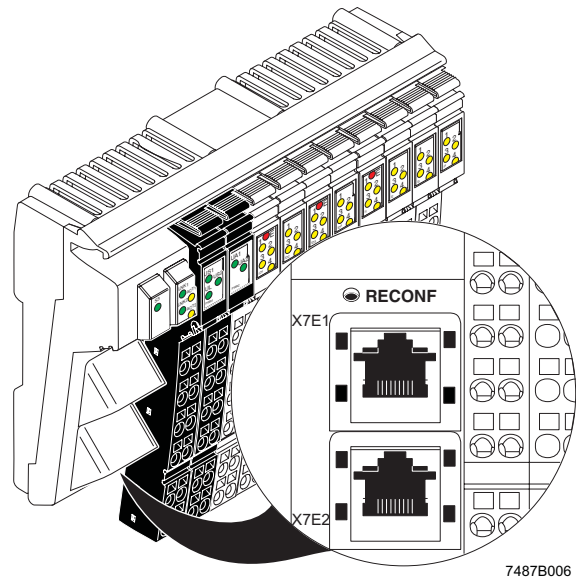

Figure 4 Pin assignment of the RJ45 female connector



7487B006

Figure 5 8-pos. RJ45 female connectors

Reconfiguration Button

The reconfiguration button is currently not supported.

Connection of Supply, Actuators, and Sensors

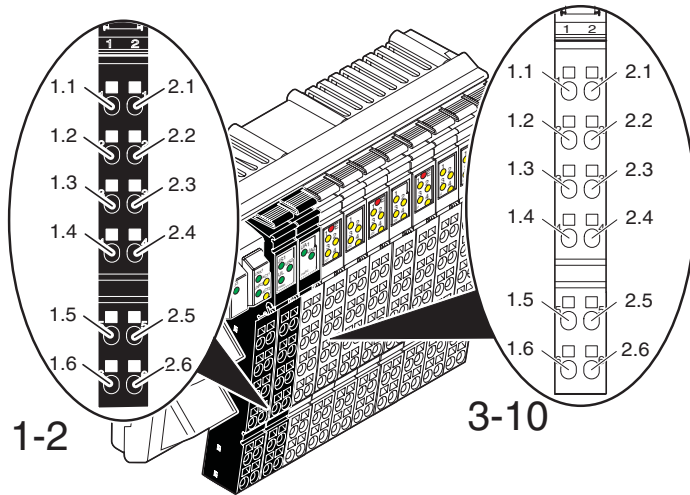

7487B003

Figure 6 Terminal point assignment of the Inline connectors

Terminal Point Assignment of the Power Connectors (Connectors 1 and 2 in Figure 6)

Terminal Point	Assignment	Terminal Point	Assignment
Connector 1 (PWR 1)			
1.1	24 V sensor supply U_{S1} (Supply for the sensors at connectors 3 to 6)	2.1	24 V sensor supply U_{S2} (Supply for the sensors at connectors 7 to 10)
1.2	24 V communications power U_L	2.2	24 V communications power U_L
1.3	GND	2.3	GND
1.4	FE	2.4	FE
1.5	24 V communications power U_L	2.5	24 V communications power U_L
1.6	GND	2.6	GND
Connector 2 (PWR 2)			
1.1	Actuator supply U_{A1} (Supply for the sensors at connectors 3 to 4)	2.1	Actuator supply U_{A2} (Supply for the sensors at connectors 5 to 6)
1.2	24 V communications power U_L	2.2	24 V communications power U_L
1.3	GND	2.3	GND
1.4	FE	2.4	FE
1.5	24 V communications power U_L	2.5	24 V communications power U_L
1.6	GND	2.6	GND



The terminal points can have a total current of 8 A per terminal point. The maximum current carrying capacity of 8 A must not be exceeded. If the total output current in your application is > 8 A, supply the module via a minimum of two terminal points connected in parallel.



The supply points have the same ground potential.

Terminal points 1.2, 1.5, 2.2, 2.5 of the PWR1 and PWR2 connectors (24 V communications power U_L) are electrically connected with one another. This means that power can be supplied via one power supply with forwarding to 1.1, 2.1 of the PWR1 connector (U_{S1} and U_{S2}) and to 1.1, 2.1 of the PWR2 connector (U_{A1} and U_{A2}). In addition, terminal points 1.3, 1.6, 2.3, 2.6 of the PWR1 and PWR2 connectors (GND) are electrically connected with one another. See connection example on page 13.

This means that power can be supplied via one power supply.

Terminal Point Assignment of the Input and Output Connectors (Connectors 3 to 6 in Figure 6 on page 11)

Terminal Point				Assignment
Connector 3 (IO1)	Connector 4 (IO2)	Connector 5 (IO3)	Connector 6 (IO4)	
1.1, 2.1	1.1, 2.1	1.1, 2.1	1.1, 2.1	Signal input (IN) or output (OUT)
1.2, 2.2	1.2, 2.2	1.2, 2.2	1.2, 2.2	Sensor voltage U_{I1} for 2 and 3-wire termination
1.3, 2.3	1.3, 2.3	1.3, 2.3	1.3, 2.3	Ground contact (GND) for 3-wire termination
1.4, 2.4	1.4, 2.4	1.4, 2.4	1.4, 2.4	Signal input (IN) or output (OUT)
1.5, 2.5	1.5, 2.5	1.5, 2.5	1.5, 2.5	Initiator supply U_{I1} for 2 and 3-wire termination
1.6, 2.6	1.6, 2.6	1.6, 2.6	1.6, 2.6	Ground contact (GND) for 3-wire termination



The channels on connectors 3 to 6 can be used as inputs or outputs. Configuration is not required.



If a channel is used as an input, this input must **not** be set as an output.

Terminal Point Assignment of the Input Connectors (Connectors 7 to 10 in Figure 6 on page 11)

Terminal Point				Assignment
Connector 7 (I1)	Connector 8 (I2)	Connector 9 (I3)	Connector 10 (I4)	
1.1, 2.1	1.1, 2.1	1.1, 2.1	1.1, 2.1	Signal input (IN)
1.2, 2.2	1.2, 2.2	1.2, 2.2	1.2, 2.2	Sensor voltage U_{I2} for 2 and 3-wire termination
1.3, 2.3	1.3, 2.3	1.3, 2.3	1.3, 2.3	Ground contact (GND) for 3-wire termination
1.4, 2.4	1.4, 2.4	1.4, 2.4	1.4, 2.4	Signal input (IN)
1.5, 2.5	1.5, 2.5	1.5, 2.5	1.5, 2.5	Initiator supply U_{I2} for 2 and 3-wire termination
1.6, 2.6	1.6, 2.6	1.6, 2.6	1.6, 2.6	Ground contact (GND) for 3-wire termination

Connection Examples

Module With Three Supplies U_L
(U_{S1} and U_{S2} Jumpered), U_{A1} , U_{A2}

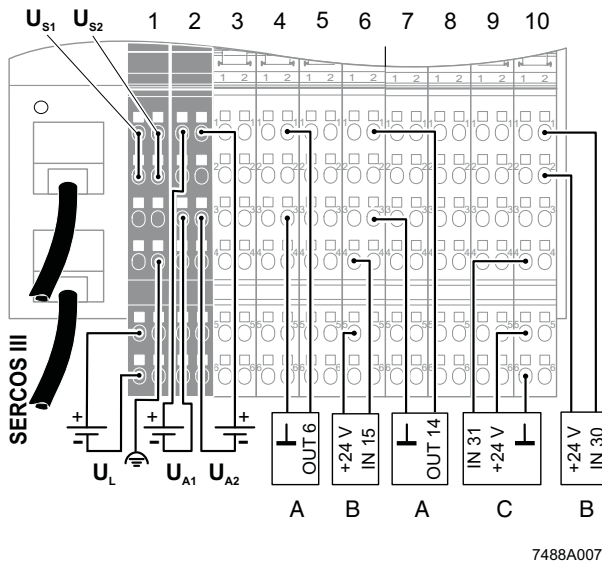

Figure 7 Connection example with three supplies

Module With One Supply U_L
(U_{S1} , U_{S2} , U_{A1} and U_{A2} Jumpered)

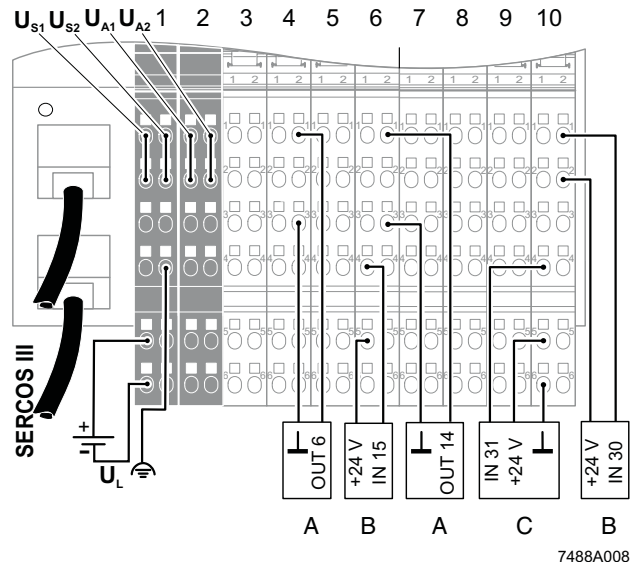

Figure 8 Connection example with one supply

- A 2-wire termination for actuator
- B 2-wire termination for sensor
- C 3-wire termination for sensor



The numbers above the module illustration indicate the connector slots.



The module has an FE spring (metal clip) on the bottom of the electronics base. This spring establishes an electrical connection to the DIN rail. Use grounding terminals to connect the DIN rail to protective earth ground. The modules are grounded when snapped onto the DIN rail. To ensure reliable functional earth grounding of the modules even when the DIN rail is dirty or the metal clip is damaged, Phoenix Contact also recommends grounding the modules via one of the FE terminal points.

Mapping of Inputs and Outputs to SERCOS III

Data Length

2 words IN/1 word OUT

Assignment of Terminal Points to the OUT Process Data Word (Slot 3 to 6)

(Word.bit) view	Word 2															
Bit	15	14	13	12	11	10	9	8	7	6	5	4	3	2	1	0
(Byte.bit) view	Byte 0								Byte 1							
Bit	7	6	5	4	3	2	1	0	7	6	5	4	3	2	1	0
Slot	4 (IO2)				3 (IO1)				6 (IO4)				5 (IO3)			
Terminal point Signal output (OUT)	2.4	1.4	2.1	1.1	2.4	1.4	2.1	1.1	2.4	1.4	2.1	1.1	2.4	1.4	2.1	1.1
Terminal point (GND)	2.6	1.6	2.3	1.3	2.6	1.6	2.3	1.3	2.6	1.6	2.3	1.3	2.6	1.6	2.3	1.3
Status indicator, LED	4	3	2	1	4	3	2	1	4	3	2	1	4	3	2	1

Assignment of Terminal Points to the IN Process Data Word (Slot 3 to 6)

(Word.bit) view	Word 0															
Bit	15	14	13	12	11	10	9	8	7	6	5	4	3	2	1	0
(Byte.bit) view	Byte 0								Byte 1							
Bit	7	6	5	4	3	2	1	0	7	6	5	4	3	2	1	0
Slot	4 (IO2)				3 (IO1)				6 (IO4)				5 (IO3)			
Terminal point Signal input (IN)	2.4	1.4	2.1	1.2	2.4	1.4	2.1	1.1	2.4	1.4	2.1	1.1	2.4	1.4	2.1	1.1
Terminal point Sensor voltage U_{I1}	2.5	1.5	2.2	1.2	2.5	1.5	2.2	1.2	2.5	1.5	2.2	1.2	2.5	1.5	2.2	1.2
Terminal point (GND)	2.6	1.6	2.3	1.3	2.6	1.6	2.3	1.3	2.6	1.6	2.3	1.3	2.6	1.6	2.3	1.3
Status indicator, LED	4	3	2	1	4	3	2	1	4	3	2	1	4	3	2	1

Assignment of Terminal Points to the IN Process Data Word (Slot 7 to 10)

(Word.bit) view	Word 1															
Bit	15	14	13	12	11	10	9	8	7	6	5	4	3	2	1	0
(Byte.bit) view	Byte 2								Byte 3							
Bit	7	6	5	4	3	2	1	0	7	6	5	4	3	2	1	0
Slot	8 (I2)				7 (I1)				10 (I4)				9 (I3)			
Terminal point Signal input (IN)	2.4	1.4	2.1	1.2	2.4	1.4	2.1	1.1	2.4	1.4	2.1	1.1	2.4	1.4	2.1	1.1
Terminal point Sensor voltage U_{I1}	2.5	1.5	2.2	1.2	2.5	1.5	2.2	1.2	2.5	1.5	2.2	1.2	2.5	1.5	2.2	1.2
Terminal point (GND)	2.6	1.6	2.3	1.3	2.6	1.6	2.3	1.3	2.6	1.6	2.3	1.3	2.6	1.6	2.3	1.3
Status indicator, LED	4	3	2	1	4	3	2	1	4	3	2	1	4	3	2	1

SERCOS III

The module supports SERCOS III V1.1.

Module-specific data is described in the following section.

I/O Control Word (Part of the Realtime Data of the Master Data Telegram (MDT))

Bit 15 (OutEn)	= 0	The outputs are disabled
	= 1	The outputs are enabled

This control bit can be used to disable and reenble the outputs. To activate the outputs, this bit must be set to 1.

I/O Status Word (Part of the Realtime Data of the Drive Telegram (AT))

Bit 15 (OutEn)	= 0	The outputs are disabled
	= 1	The outputs are enabled
Bit 13 (C1D error)	= 0	No error has occurred
	= 1	An error has occurred, error class 1 Class 1 diagnostics can be read with S-0-0390 Class 1 diagnostics are saved and can be deleted with S-0-0099
Bit 12 (C2D warning)		Not supported

S-0-1300	Electronic Label	
S-0-1300.x.1	Component Name	Digital Block I/O
S-0-1300.x.3	Vendor Code	000000xx _{hex}
S-0-1300.x.4	Device Name	ILB S3 24 DI16 DIO16-2TX
S-0-1300.x.5	Vendor Device ID	2897570
S-0-1300.x.7	Revision	xxxx _{hex}
S-0-1300.x.12	Serial Number	10-digit, hexadecimal notation
S-0-1300.x.20	Operational Hours	Number of operating hours

S-0-0390	Diagnostic Number	
0F013410 _{hex}	Sensor supply U _{S1} or U _{S2} not present/too low	
0F012344 _{hex}	One or more outputs short-circuited or overloaded	
0F012345 _{hex}	Sensor supply U _{S1} or U _{S2} short-circuited/overloaded	

Startup

Default Upon Delivery

By default upon delivery, the following features are available:

SERCOS address = 55

Reconfiguration Button

The reconfiguration button is currently not supported.

SERCOS Address Assignment

- There is no switch for setting the SERCOS address
- The module supports automatic address assignment for the SERCOS address according to SERCOS III
- The SERCOS address is saved retentively



For additional information about automatic address assignment, please refer to the SERCOS III master documentation.

© PHOENIX CONTACT 09/2007